

RADIO-CRAFT

HUGO GERNSBACK, *Editor*



WAR

— WITH WORD BULLETS

See Page 456



GUNNER'S THROAT MIKE



2-WAY CAR FACSY



RADIO BLIND LANDING



LILLIPUTIAN TUBES!

FEB. 40 RADIO'S GREATEST MAGAZINE

25c

SMALL-TOWN SERVICE SHOP • SCRATCH FILTERS • P.E.-CELL SALES
EASILY-BUILT 2-IN-1 BATTERY RADIO SET • 3-TUBE HEARING AID

IN U. S. AND CANADA

★ ★ ★ **THREE STAR RADIO VALUE**
 You receive valuable subscription to **RADIO-CRAFT**
 PLUS A FREE COPY of 1940 Radio-Television Reference Annual

WITH our compliments, we want to send a copy of the 1940 RADIO-TELEVISION REFERENCE ANNUAL to you FREE, if you will simply take advantage of RADIO-CRAFT magazine's special subscription offer NOW. This offer is being made for a limited time only.

The 1940 RADIO-TELEVISION REFERENCE ANNUAL has 68 pages, large size 8 1/2 x 11 1/2, with over 170 illustrations. The contents of this book has never appeared before in handy book form. Its pages cover practically every branch of radio sound, public address, servicing, television, construction articles for advanced radio men and technicians, time and money-saving kinks, wrinkles, useful circuit information, "ham" transmitters and receivers, and a host of other data.

The Annuals have always been regarded as a standard reference work for every practical branch of radio operation and service. This 1940 edition ably sustains this reputation. Every radio man wants a copy of this valuable book. Just as this book will be of unquestionable value to you, so, too, will every monthly issue of RADIO-CRAFT. This magazine brings you big value every month. It keeps you intelligently informed about new developments in radio and television. You want the news, want it fully but concisely, want it first—that is why you should read RADIO-CRAFT regularly.

This very special offer is made for just one purpose—we want you as a regular subscriber. The Annual, whose contents appears at the right, is not sold, but a copy is FREE to you if you subscribe now.

**SAME SIZE AS
 RADIO-CRAFT**

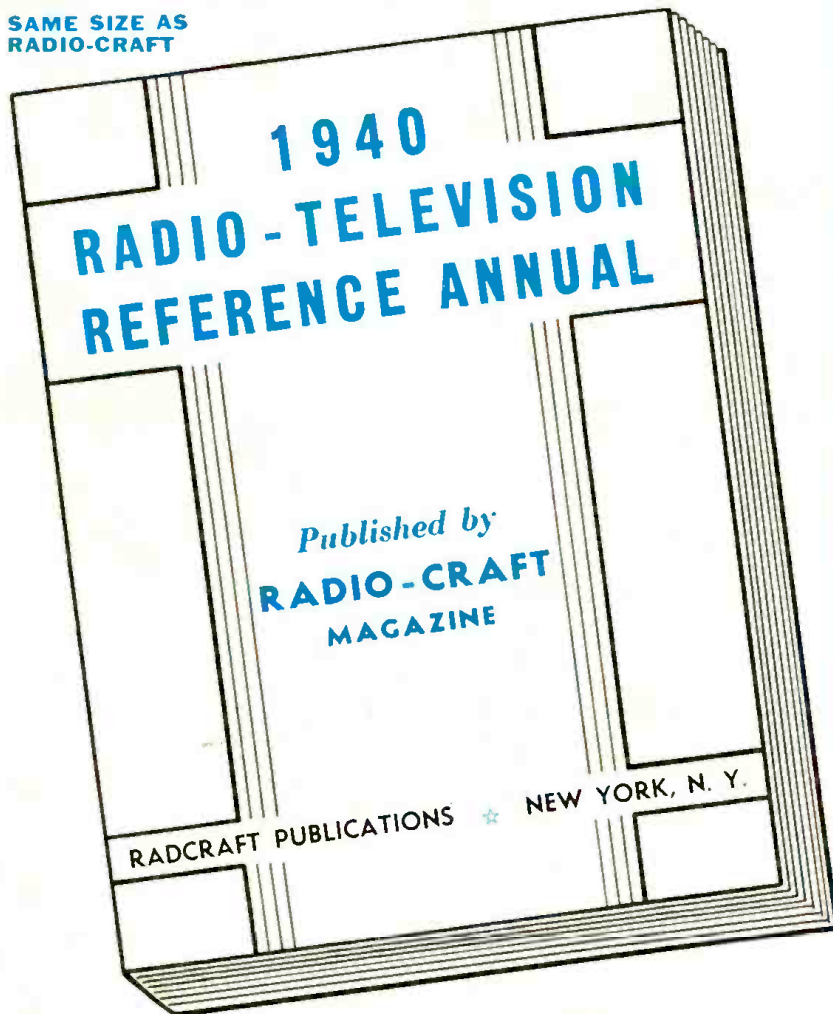

THIS COUPON BRINGS YOU THE ANNUAL

RADIO-CRAFT • 99 HUDSON STREET • NEW YORK, N. Y.

Gentlemen: Enclosed you will find One Dollar for which enter my subscription to RADIO-CRAFT Magazine for Eight Months. Send me **ABSOLUTELY FREE** and **POSTPAID**, my copy of 1940 RADIO-TELEVISION REFERENCE ANNUAL.

This is a new order Extend My Present Subscription

NAME ADDRESS

CITY STATE

DON'T DELAY — MAIL TODAY! RC-210

**Read the summary of contents
 in this FREE BOOK!**

THE 1940 RADIO-TELEVISION REFERENCE ANNUAL contains a collection of the best and most important articles. Covering as they do nearly every branch of radio, they form a handy reference works. In addition, many time and labor-saving kinks, circuits and wrinkles, tried and tested by practicing Servicemen, experimenters and radio fans have been included. This book cannot be bought anywhere at any price. Yet it is yours by merely subscribing. Use the convenient coupon below.

**BEGINNER'S SIMPLE INEXPENSIVE
 CONSTRUCTION ARTICLES**

Beginner's Breadboard Special - a 1-Tube High-Gain All-Wave Receiver Wiring Pointers for Radio Beginners—A Watch Charm Size 1-Tube Set—Beginner's Simple Volt-Milliammeter—Making a 1-Tube Broadcast Loop Receiver—A.C.-D.C. Power Supply for Battery Portables—A 1-Tube Short-Wave with Band Coil Switching.

MORE ADVANCED SET CONSTRUCTION

The "High Seas 4" Broadcast Loop Radio—How to Build a 6-Tube 141 Volt Short-Wave Superhet for the "Ham" or Short-Wave Fan—Build the "Lunch Box 5" Super Set - a Broadcast Battery Portable—How to Build a Plug-Together 8 Tube Broadcast Set—The "5-in-1" All-Wave Radio for A.C. Operation—An Easily-Built 3-Tube Midrange Broadcast Superheterodyne Receiver.

THE SERVICEMEN'S SECTION

Bass Tone Control—Simplified Variable Selectivity—Practical Servicing Pointers—Servicing Universal A.C.-D.C. Receivers—Killing the "Intermittent" Bug—A Service Shop A.C. to D.C. Power Supply—Shedline Money for Servicemen—Adding A.V.C. to any Screen-Grid T.R.F. Receiver—Iron Particles in Speaker Air Gap.

TEST INSTRUMENTS

A Useful Neon Lamp Tester—An Inexpensive Output Meter—Making Milliammeter Multipliers—Home-Made Frequency Modulator—The Busy Servicemen's V.T. Volt-Meter.

PUBLIC ADDRESS AND AMPLIFIERS

Build this Combination A.C.-D.C. Radio and Inter-Communicator Speaker Placement in P.A. Work—The Design and Construction of an Inexpensive All-Push-Pull 10-Watt Amplifier—Obscure Sources of Hum in High-Gain Amplifiers—How to Build a High-Fidelity 5-Watt Versatile Amplifier.

"HAM" SECTION

Ultra High Frequency Antennas—The Beginner's Low-Cost Xmitter-Modulator Meter—Phone Monitor—The Beginner's "Ham" Receiver—2 1/2 Meter Acorn Transceiver.

TELEVISION

How to Build a 441 Line T.R.F. Television Receiver—Useful Notes on Television Antennas.

MISCELLANEOUS

Simple Photo Cell Relay Set Up—Making a Burglar Alarm—How to Build A.C. D.C. Capacity Relay—How to Make a Modern Radio Treasure Locator.

USEFUL KINKS, CIRCUITS AND WRINKLES

Making a Flexible Coupler—Two-Timing Chime—A Simple Portable Aerial—An Improvised Non Slip Screw-Driver. NOTE: The book contains numerous other useful Kinks, Circuits and Wrinkles, not listed here.

(approximately)

45 ARTICLES

(approximately)

170 ILLUSTRATIONS

68 BIG PAGES

RADIO-CRAFT
99 HUDSON STREET
NEW YORK, N. Y.

Read what happened



YES!

I'll take your training. That's what S. J. Ebert said. He is making good money and has found success in Radio.

to these two men when I said:



NO!

I'm not interested. That's what this fellow said. Today he would be ashamed if I told you his real name and salary.

I will Train You at Home in Spare Time for a GOOD JOB IN RADIO

These two fellows each clipped and sent me a coupon, like the one in this ad. Both were interested in getting a good job in Radio—a field with a future. They got my book on Radio's opportunities, found out how I trained men at home to be Radio Technicians. S. J. Ebert, 104-B Quadrangle, University of Iowa, Iowa City, Iowa, saw Radio offered him a real chance. He enrolled. The other fellow, whom we will call John Doe, wrote he wasn't interested. He was just one of those fellows who wants a better job, better pay, but never does anything about it. Now, read what S. J. Ebert writes me and remember that John Doe had the same chance: "Upon graduation I accepted a job fixing Radio sets, and within three weeks was made Service Manager of a Radio store. This job paid me \$40 to \$50 a week compared with \$18 I earned in a shoe factory. Eight months later I went with Station KWCR as operator. From there I went to KTNT. Now I am Radio Engineer with WSUI. I certainly recommend N.R.I. to all interested in the greatest field of all, Radio."

Why Many Radio Technicians Make \$30, \$40, \$50 a Week

Radio broadcasting stations employ engineers, operators, technicians and pay well for trained men. Radio manufacturers employ testers, inspectors, foremen, servicemen in good-pay jobs with opportunities for advancement. Radio jobbers and dealers employ installation and servicemen. Many Radio Technicians open their own Radio sales and repair businesses and make \$30, \$40, \$50 a week. Others hold their regular jobs and make \$5 to \$10 a week fixing Radio in spare time. Automobile, police, aviation, commercial Radio; loudspeaker systems, electronic devices, are newer fields offering

SAMPLE LESSON FREE

I want to prove our Course gives practical, money-making information. That it is easy to understand—what you need to master Radio. My sample lesson text, "Radio Receiver Troubles—Their Cause and Remedy," covers a long list of Radio receiver troubles in A.C., D.C., battery, universal, auto, T.R.F., super-rodynic, all wave, and other types of sets. And a cross reference system gives you the probable cause and a quick way to locate and remedy these set troubles. A special section is devoted to receiver check-up, alignment, balancing, neutralizing, testing. You can get this lesson free by mailing the coupon.

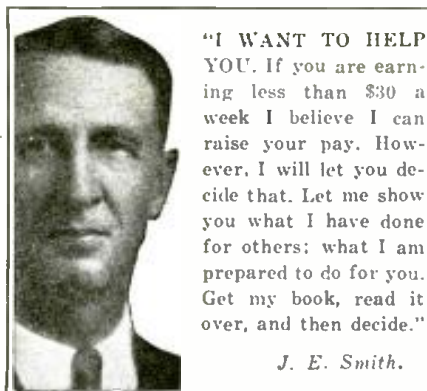

"I WANT TO HELP YOU. If you are earning less than \$30 a week I believe I can raise your pay. However, I will let you decide that. Let me show you what I have done for others; what I am prepared to do for you. Get my book, read it over, and then decide."

J. E. Smith.

good opportunities to qualified men. And my Course includes Television, which promises to open many good jobs soon.

Many Make \$5 to \$10 a Week Extra in Spare Time While Learning

The day you enroll, in addition to my regular Course, I start sending you Extra Money Job Sheets which start showing you how to do actual Radio repair jobs. Throughout your Course I send plans and directions which have helped many make \$200 to \$500 a year in spare time while learning. I send special Radio equipment; show you how to conduct experiments, build circuits. This 50-50 training method makes learning at home interesting, fascinating, practical.

I Also Give You This Professional Servicing Instrument

Here is the type of instrument Radio Technicians use—an All-Wave Set Servicing Instrument. It contains everything necessary to measure A.C. and D.C. voltages and current; to check resistances; adjust and align any set, old or new. It satisfies your needs for professional servicing after you graduate—can help you make extra money fixing sets while learning.



You Are Trained for Television Also

With N.R.I. you learn Television principles right along with Radio principles—the correct method—since Television receivers combine both sight and sound. You also get more than ten text books devoted entirely to Television.

Sample Lesson and 64-Page Book Free

Act today. Mail coupon now for Sample Lesson and 64-page Book. They're FREE. They point out Radio's spare-time and full-time opportunities and those coming in Television; tell about my course in Radio and Television; show many letters from men I trained, telling what they are doing and earning. Read my money back agreement. Find out what Radio offers you. Mail coupon in envelope or paste on penny postcard—NOW!

J. E. SMITH, President
Dept. OBX, National Radio Institute
Washington, D. C.



FOR FREE BOOK OF FACTS ABOUT RADIO

J. E. Smith, President, National Radio Institute
Dept. OBX, Washington, D. C.

Without obligating me, send your Sample Lesson and 64-page Book FREE. I am particularly interested in the branch of Radio checked below.

- Radio Service Business of My Own
- Spare Time Radio Repair Work
- Service Technician for Retail Stores
- Broadcasting Station Operator
- Loud Speaker Systems, Installations and Service
- Auto Radio Installation and Service
- Television Station Operator
- All-around Servicing Technician

(If you have not decided which branch you prefer—mail coupon now, for information to help you decide.)

Name Age

Address

City State 14X1

Please Say That You Saw It in RADIO-CRAFT

RADIO-CRAFT

HUGO GERNSBACK, *Editor-in-Chief*

N. H. LESSEM
Associate Editor

THOS. D. PENTZ
Art Director

ROBERT EICHBERG
Trade Digest Editor

R. D. WASHBURNE, *Managing Editor*

Contents FEBRUARY, 1940 Issue

VOLUME XI -- NUMBER 8

Editorial: Radio "Radio" Broadcasting.....	Hugo Gernsback	453
The Radio Month in Review.....		454
Radio Pictorial		456
3-Tube Ultra-Compact Deaf-Aid.....		457
Recent Test Equipment.....	N. H. Lessem	458
Selling and Installing "Electric Eye" Equipment.....	M. N. Beitman	460
Newest Radio-Directed Blind-Landing System.....		462
Easily-Built 2-in-1 "Card File" Battery Set.....	Beryl B. Bryant	464
Radically New Miniature Tubes.....	R. D. Washburne	465
Build This 1- to 15-Meter 6-Tube Superhet. Radio	Geo. F. Baptiste, W3G8	466
Sound Engineering—No. 2.....	Conducted by A. C. Shaney	468
Newest Electronic Piano.....		469
New Circuits in Modern Radio Receivers—No. 29....	F. L. Sprayberry	470
Servicing Puzzlers—No. 2.....		471
Scratch Filter Design.....	H. S. Manney	472
Servicing Questions & Answers.....		474
P.A. Sale to Skating Rink.....	W. L. Fuller, Jr.	474
How to Select and Place Sound Equipment—Part II—Loudspeakers		475
My Small-Town Service Shop.....	Roy Powell	476
Useful Kinks and Circuits.....		477
RADIO SERVICE DATA SHEETS:		
No. 270—Stromberg-Carlson No. 425 Frequency Modulation Re- ceiver and "Converter".....		478
No. 271—Ditto (Stromberg-Carlson No. 425 Unit).....		479
Mailbag		480
Radio Trade Digest.....		481
Latest Radio Apparatus.....		486
Operating Notes		507
Radio Happenings in Brief.....		508
Book Reviews		451

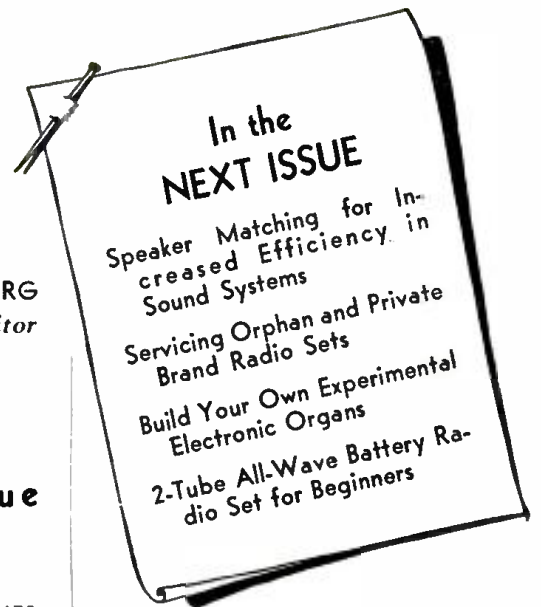

★

There are under development several radically new devices which will be described in *Radio-Craft* for the first time in any radio publication. Like the construction article in January *Radio-Craft* on a frequency-modulation adapter, and the many other original stories which broke for the first time in *Radio-Craft*, these new construction articles will set precedence which soon will be followed by manufacturers; but equipment builders by being given complete construction information will be able to get in on the ground floor in the development of these new devices.

It would be premature to discuss these developments in detail but suffice it to say that the ideas are so original that only in forthcoming issues of *Radio-Craft* will these developments be seen for the first time.

★

Published by Radcraft Publications, Inc. Publication office: 29 Worthington Street, Springfield, Mass. Editorial and Advertising Offices: 99 Hudson Street, New York City. Chicago Advertising Office: RADIO-CRAFT, 520 North Michigan Avenue, Chicago, Ill.

RADIO-CRAFT is published monthly, on the first of the month preceding that of date; subscription price is \$2.00 per year in U. S. and Canada. (In foreign countries, \$2.50 a year to cover additional postage.) Entered at the post office at Springfield as second-class matter under the act of March 3, 1879.

Foreign Agents:

London—Gorrings's American News Agency, 9A Green St., Leicester Square, W. C. 2, England.

Paris—Messageries Dawson, 4 Rue Faubourg, Poissonniere, France.

Melbourne—McGill's Agency, 179 Elizabeth St., Australia.

Dunedin—James Johnston, Ltd., New Zealand.

★

Text and illustrations of this magazine are copyright and must not be reproduced without permission of the copyright owners.

★

Copyright 1940 Radcraft Publications, Inc.

BOOK REVIEWS

THE RADIO AMATEUR'S HANDBOOK 1940. Published by The American Radio Relay League. Size 6½ x 9½ ins., stiff paper cover, completely illustrated, 456 pgs. Price \$1.00.

This "bible" of the transmitting amateur will be of especial benefit to the approximately 58,000 licensed amateurs in the U.S. and the additional tens of thousands throughout the world; this new 17th Edition presents an invaluable technical delineation of every single phase of radio reception and transmission for the more efficient conduct of amateur radio.

A considerable portion of the material in this book will be of interest, however, to practicing radio men everywhere. Its 8-pg. index is a roster of references for up-to-the-second information on every topic concerning radio transmission and reception on wavelengths below 200 meters. There is no better value in the field of radio publications.

EDISON'S OPEN DOOR, by Alfred O. Tate (1938). Published by E. P. Dutton & Co., Inc. Size 6 x 9 ins., cloth cover, 320 pgs. Price \$3.00.

Here is, to quote the subtitle, "The Life Story of Thomas A. Edison. A Great Individualist," by his private secretary. Many books have been written around the colorful life of the Wizard of Menlo Park, but none have been of a more entertaining or illuminating nature than the story which Mr. Tate, life member and gold medalist of the Franklin Institute, and past vice-president of the Edison Pioneers, has written as a truthful narrative.

The story opens with description of the author's birthplace and early life as a backlog against which the word-artist paints the picture of the human-interest side of Thomas A. Edison, during the 11 years of Mr. Tate's contact with him, and concludes with the eulogy to Mr. Edison delivered by the author, in memoriam, at the first memorial meeting of the Edison Pioneers in 1932.

THEORY AND APPLICATIONS OF ELECTRON TUBES, by Herbert J. Reich (1939). Published by McGraw-Hill Book Co., Inc. Size, 6½ x 9¼ ins., cloth cover, completely illustrated, 670 pgs. Price, \$5.00.

States the wrapper of this book, "The purpose of this important book is to give the student a sufficiently thorough grounding in the fundamental principles of electron tubes and associated circuits to enable him to apply electron tubes to the solution of new problems. The book is exceptionally complete, including a wealth of material logically assembled and coordinated."

Serious radio men always have in their libraries a few books to which they can turn as "final authorities" in settlement of the more technical problems in radio which the ordinary run-of-the-mill books are not able to solve. "Theory and Applications of Electron Tubes," by Dr. Reich, in its comprehensive treatment of all phases of electron tube operation offers just such a book to the radio technician. It is based upon mimeographed notes that have been used in the author's courses on electron tubes in the last 5 yrs.

Chapter headings follow: Physical Concepts; Thermionic Emission. The High-Vacuum Thermionic Diode; Grid-Controlled High-Vacuum Tubes; Methods of Analysis of Vacuum Tubes and Vacuum-Tube Circuits; Modulation and Detection; Amplifier Definitions, Classifications, and Circuits; Analysis and Design of Voltage and Current Amplifiers; Class A and Class AB1 Power Amplifiers; Class B, Class AB2, and Class C Amplifiers. Vacuum-Tube Oscillators; Electrical Conduction in Gases; Glow- and Arc-Discharge Tubes and Circuits; Light-Sensitive Tubes and Cells; Power Supplies; Electron-Tube Instruments and Measurements; Appendix.

ELECTROLYTIC CAPACITORS, by Paul McKnight Deeley (1938). Published by The Cornell-Dubilier Electric Corp. Size 5½ x 8 ins., cloth cover, completely illustrated, 276 pgs. Price \$3.00.

It is believed that his new book by the Chief Engineer of "C.-D." covers the theory, construction, application, and characteristics of electrolytic condensers with exceptional completeness.

We quote from the author's preface, "It is well recognized that the various fabricators of electrolytic capacitors have many processes that may

be termed 'trade secrets' and for that reason the author has studiously avoided the disclosure of any data relating to such processes. On the other hand, special effort has been made to cover the subject of electrolytic capacitors in sufficiently great detail to provide the reader with authentic and useful information."

Chapter headings: Electrolytic Capacitors; Basic Theory of Operation of Electrolytic Capacitors; Types of Electrolytic Capacitors; The Fabrication of Wet Electrolytic Capacitors; Formation of Anodic Films; Aging and Characteristics of Wet Electrolytic Capacitors; The Dry Type of Electrolytic Capacitor; The Fabrication of Dry Electrolytic Capacitors; Formation of the Anodic Film; Non-Aqueous Electrolytes and Their Characteristics; Winding and Impregnation of Dry Electrolytic Capacitors; Types of Dry Electrolytic Capacitors; Characteristics and Aging of Dry Electrolytic Capacitors; Testing of Electrolytic Capacitors; Rectifiers and Filter Circuits; Alternating Current Type of Electrolytic Capacitors; Appendix of Useful Information.

DEMONSTRATION EXPERIMENTS IN PHYSICS, edited by Richard Manliffe Sutton (1938). Published by McGraw-Hill Book Co., Inc. Size, 6½ x 9¼ ins., cloth cover, 108 illustrations, 545 pgs. Price \$1.50.

Everyone regardless of whether he is interested in radio should have a thorough grounding in physics for only with such knowledge is it possible to fully appreciate and cope with modern, scientific methods of living in every walk of life. Radio students everywhere of course will derive additional benefit from "Demonstration Experiments in Physics," for without physics there can be no radio. In this book is a collection of nearly 1,200 lecture-experiments, including contributions from 200 physicists in 130 institutions.

Description of experiments are direct, and emphasis has been placed upon simplicity of apparatus and procedure; in many cases hitherto unpublished descriptions of experiments are given; of exceptional interest is the fact that the author utilizes a wide range of analogies based on familiar things to emphasize essential principles.

Chapter headings are: Mechanics; Wave Motion and Sound; Heat; Electricity and Magnetism; Light; Atomic and Electronic Physics.

EDUCATION ON THE AIR, edited by Josephine H. MacLachy (9th Yearbook—1938). Published by Ohio State University. Size 6½ x 9¼ ins., cloth cover, 351 pgs. Price, \$3.00.

This 9th Yearbook of the Institute for Education by Radio brings up-to-date the wide variety of topics embraced in the radio operations of Ohio State University. An exceptionally valuable listing is a 6-pg. bibliography of radio education.

Chapter headings follow: Radio and General Education; Radio and the Listener; School Broadcasts; Radio and the University; Educational Broadcasts by Commercial Stations; Types of Programs; Technical Developments in Broadcasting; Second Annual Exhibition of Recordings; Bibliography.

CATHODE MODULATION, by France C. Jones (1939). Published by Pacific Radio Publishing Co., Inc. Size 8½ x 11 ins., stiff paper cover, completely illustrated, 86 pgs. Price, \$1.00.

This book, which carries the subtitle "An Economical and Efficient System of Modulation for Radiotelephony," will be a revelation to radio men who previously were unaware of the at least 12 advantages of the uses of cathode modulation, in transmitters, which Mr. Jones lists; it is around this listing that the extensive story which constitutes the subject of "Cathode Modulation" is built. The book is the best-illustrated publication of its type so far to come to the attention of this desk; diagrams, in particular, are unusually readable.

Chapters: Cathode Modulation; Amplifier Circuit Constants and Tube Characteristics for Cathode Modulation; Construction of Cathode-Modulated Radiotelephone Transmitters.

HOW TO BUILD THE RADIO AUDIENCE, by Douglas Duff Connah (1938). Published by Harper & Brothers. Size, 6½ x 9½ ins., cloth cover, illustrated, 271 pgs. Price, \$3.00.

This book is in 2 parts: Public Relations Factors in Commercial Broadcasting; and, Audi-

I'll Help YOU SMASH YOUR WAY To Bigger Income in RADIO AND TELEVISION

I Train You Quickly in Your Spare Hours . . . Right at Home

You Do Practical Experiments with Real Equipment

I offer you a new and altogether different type of practical training for a money-making career in Radio and Television. I teach you in a simplified, logical, understandable style . . . all about Television, Electronics, Facsimile Radio, Radio Set Repair and Installation. I GIVE YOU PERSONAL COACHING ALL THE WAY.

TRAINING PREPARES YOU FOR GOOD RADIO JOBS at Excellent Pay

No matter if you desire to BE YOUR OWN BOSS in your own business or hold down a good job in Radio, my training will give you the useful information and knowledge to win success. DON'T JUST WAIT FOR MORE MONEY—START TRAINING FOR IT RIGHT NOW.

Read What This Student Says:
EARNED \$250 SINCE STARTING COURSE

"I have only completed one-third of the Sprayberry Course and I find it very interesting, which makes it easy to learn. . . . By devoting several hours of my spare time daily to studying and servicing, I have made about \$250 gross since starting the course." Earl W. Hostetter, R. No. 4, Lebanon, Pa.

YOU GET PROFESSIONAL TEST EQUIPMENT PLUS EXPERIMENTAL OUTFITS

Includes 146 RADIO PARTS for building a complete Radio Receiver, RADIO TOOLS, ALL-WAVE, ALL-PURPOSE ANALYZER. Besides its invaluable use in experimental work, my equipment will enable you to make spare time profit while you're learning and can serve you in your own Service business later on. I give you DATA SHEETS on how to build popular Radio circuits. Also you receive BUSINESS BUILDERS which show you how to get and do spare time, neighborhood Radio Service work.

NO PREVIOUS EXPERIENCE NEEDED

My training starts right at the beginning of Radio . . . covers all essential subjects. It makes no difference what your education has been. I can fit you for an excellent paying job in Radio. Your success is my full responsibility. I know how to get Radio across so that you will understand it and remember it.

146 RADIO PARTS
RADIO TOOLS
ALL PURPOSE ANALYZER

SERVICEMEN

I offer Advanced Training for those already in Radio. Get complete details in my FREE 52-page Book. REMEMBER—THE SPR' COURSE IS SOLD MONEY-BACK.

RUSH

SP. F. 320-4
Please MONEY
Name . . .
Address . . .
City . . .
Tear off this penny postcard.

RADIO
95 HUDSON

Order 25c
size. To
your
concern

Please Say That You Saw It in RADIO-CRAFT

For Better Servicing - For Bigger Profits - USE GERNSBACK MANUALS AND BOOKS!



SINCE 1931 Servicemen have been buying more GERNSBACK OFFICIAL RADIO SERVICE MANUALS year after year. The authentic material, easily accessible diagrams and complete service data make them invaluable to dealers and radio Servicemen. Without a Gernsback Service Manual at the repair job, there's time and profit lost. Your service kit or laboratory is incomplete without all the GERNSBACK OFFICIAL RADIO SERVICE MANUALS. There are GERNSBACK MANUALS for servicing auto-radios, also refrigeration and air conditioning equipment.

VOLUME 7 OFFICIAL RADIO SERVICE MANUAL
Over 1,800 Pages • Over 3,000 Illustrations • Stiff, Leatherette, Looseleaf Covers • Size 9 x 12 Inches • Net Weight 10½ lbs. **\$10.00**

1936 OFFICIAL RADIO SERVICE MANUAL
Over 1,200 Pages • Over 2,500 Illustrations • Stiff, Leatherette, Looseleaf Covers • Size 9 x 12 Inches • Net Weight 8 lbs. **\$7.00**

1935 OFFICIAL RADIO SERVICE MANUAL
Over 1,000 Pages • Over 3,000 Illustrations • Flexible, Leatherette, Looseleaf Covers • Size 9 x 12 Inches • Net Weight 3½ lbs. **\$7.00**

1935 OFFICIAL AUTO-RADIO SERVICE MANUAL
Over 240 Pages • Over 500 Illustrations • Flexible, Leatherette, Looseleaf Covers • Size 9 x 12 Inches • Net Weight 1¾ lbs. **\$2.50**

1934 OFFICIAL RADIO SERVICE MANUAL
Over 400 Pages • Over 2,000 Illustrations • Flexible, Leatherette, Looseleaf Covers • Size 9 x 12 Inches • Net Weight 2¾ lbs. **\$3.50**

1932 OFFICIAL RADIO SERVICE MANUAL
Over 1,000 Pages • Over 2,000 Illustrations • Flexible, Leatherette, Looseleaf Covers • Size 9 x 12 Inches • Net Weight 4½ lbs. **\$5.00**

OFFICIAL REFRIGERATION SERVICE MANUAL
(Volume 11)
Over 352 Pages • Over 300 Illustrations • Flexible, Leatherette, Looseleaf Covers • Size 9 x 12 Inches • Net Weight 1½ lbs. **\$5.00**

OFFICIAL AIR CONDITIONING SERVICE MANUAL
Over 600 Pages • Over 800 Illustrations • Flexible, Leatherette, Looseleaf Covers • Size 9 x 12 Inches • Net Weight 2¾ lbs. **\$5.00**

Order these famous Manuals, see or write to your dealer or favorite mail order house. If more convenient, mail coupon directly to publishers.

RADIO-CRAFT PUBLICATIONS, Inc.
100 WEST 42ND STREET NEW YORK, N. Y.

Many New Books Have Been Added to RADIO-CRAFT LIBRARY SERIES

Get into the swing of reading instructive, authoritative books on technical subjects—radio, air conditioning and refrigeration. It's the easiest, quickest and most inexpensive way to improve your knowledge on these topics. In this series, popularly known as the RADIO-CRAFT LIBRARY SERIES, are all the titles necessary to your personal advancement. Only by careful study of these enlightening books, can you gain adequate experience in fields of radio, air conditioning and refrigeration. Each book is uniform. The volumes measure 6 x 9 inches—contain 64 pages, and have stiff, flexible covers. PRICE 50c PER BOOK. All books are sent to you postpaid.

Here Are The Titles:

- | | |
|---|---|
| Book No. 2
MODERN VACUUM TUBES | Book No. 18
POINT-TO-POINT RESISTANCE ANALYSIS |
| Book No. 6
BRINGING ELECTRIC SETS UP-TO-DATE | Book No. 19
PRACTICAL RADIO KINKS AND SHORT CUTS |
| Book No. 13
ABC OF AIR CONDITIONING | Book No. 20
THE CATHODE-RAY OSCILLOSCOPE |
| Book No. 14
POCKET RADIO GUIDE | Book No. 21
BREAKING INTO RADIO SERVICING |
| Book No. 15
ABC OF REFRIGERATION | Book No. 22
NEW RADIO QUESTIONS AND ANSWERS |
| Book No. 16
PRACTICAL RADIO CIRCUITS | Book No. 23
PRACTICAL PUBLIC ADDRESS |
| Book No. 17
SERVICING WITH SET ANALYZERS | |

EACH BOOK IN THIS SERIES—50c

RAD-CRAFT PUBLICATIONS, Inc., 99 HUDSON ST., NEW YORK, N. Y.
Gentlemen: Enclosed find my remittance of \$..... for which send me, POSTPAID, the Manuals or Books indicated below by a cross (x) in the Panel.
() Volume 7 @ \$10.00 () 1936 Manual @ \$7.00 () 1935 Manual @ \$7.00
() 1935 Auto-Manual @ \$2.50 () 1934 Manual @ \$3.50 () 1932 Manual @ \$5.00
() Refrigeration Manual (Vol. 2) @ \$5.00 () Air Conditioning Manual @ \$5.00

RADIO-CRAFT LIBRARY SERIES @ 50c EACH
Circle book numbers wanted: 2 6 13 14 15 16 17 18 19 20 21 22 23

Name Address

City State

(Send remittance in form of check or money order; register your letter if you send cash or unused U. S. Postage Stamps.) RC-240

Please Say That You Saw It in RADIO-CRAFT

RADIO-CRAFT

“RADIO'S GREATEST MAGAZINE”

RADIO “Radio” BROADCASTING

By the Editor—HUGO GERNSBACH

THE standard method of network broadcasting ever since its inception has been to link the various radio stations by telephone wires thus forming a *wire-linked* radio station network embracing the entire country.

When broadcasting first started, the thought uppermost in radio engineers' minds was to link the stations together not by wire but by radio. This logical thought, however, met with insuperable obstacles, most of which can be boiled down into one word—“static.”

There was entirely too much noise that crept into the radio transmission if the linking-up between stations was made; and there were other technical difficulties not necessary to relate here. The fact was that a *radio-linked* network remained an impossibility.

Broadcast stations which wished to be linked together had only one other choice and that was to be linked together by wire, and this is exactly what they did. Up to very recently, therefore, all stations linked into a network used special telephone wires which connected all stations together. It is interesting, particularly to the layman, to note that these are not just ordinary telephone wires but they have to be specially balanced and noise-free lines for high-quality reproduction. When the key network station in New York sends out a program, this program, through suitable amplifiers and filters, is then piped through the American Telegraph and Telephone Co.'s wires from coast to coast as the need may be. At various points along the route there are other amplifiers (boosters), and other means whereby the quality of the wired program is kept at a high level. By telephone feeder wires it reaches the other radio stations comprising the network. The system as we now have it is technically excellent, the only drawback being the huge cost of the telephone lines to the broadcasters. The magnitude of this objection can be readily understood if we know that American broadcast stations paid-out for lease of telephone wires for broadcasting purposes, in one year, the tremendous sum of \$5,710,222.*

Small wonder then that for over 25 years engineers have battled with the problem of doing away with wire lines linking stations together and using radio links instead. Not much progress was made during the years except here and there where the broadcasters availed themselves of rebroadcasting shortwave programs originating at a distance. Even this has its drawbacks because the quality frequently suffers.

Take, for instance, the splendid effort now being made by the National Broadcasting Company, the Mutual Broadcasting System, and the Columbia Broadcasting System. These 3 organizations bring us from day to day foreign programs from the European capitals. These programs originate in Europe and are of course transmitted by radio, picked up on the Eastern seaboard, amplified and then put on the air again on the regular broadcast channels. While most of the time the talk is intelligible it suffers from static and other atmospheric conditions. This difficulty up to now has not been overcome.

The advent of Major Edwin H. Armstrong's *Wide-Band*

*A Federal Communications Commission survey for all stations, in 1937 (later figures are unavailable; figure includes all wire lines (network links, remote pick-ups, etc.).

Frequency Modulation System has changed all this and it appears now that during the next 10 years not only will radio itself be revolutionized, as reported in my last month's editorial entitled “‘Static-Less’ Radio” but it seems certain that radio broadcasting also will be revolutionized, completely. The key which solves the problem of linking stations together is found in the Frequency Modulation System. During the early part of last December Major Armstrong amazed guests at a Meriden, Connecticut, demonstration by a *triple-relayed* radio program without wires! This memorable experiment took place at station WDRC at Meriden, Conn., on December 4th. It was termed “amazing” by sceptical radio technicians who witnessed the new System. The following is the method used at that time.

From Major Armstrong's Frequency-Modulated Station W2XCR, at Yonkers, N. Y., a program was broadcast, which in turn was picked up by another, similar frequency-modulated station, W2XMN, at Alpine, N. J. This station then put the program on the air; in turn, this program was picked up by W1XPW—also a frequency-modulated transmitter (for station WDRC in Meriden, Conn.). Then station W1XPW in turn rebroadcast the Yonkers program which was received at the Meriden WDRC studios.

It would be thought that by triply relaying a radio broadcast program in this manner the quality would suffer, as each station rebroadcast the program that was fed to it from another station. The engineers dazedly confessed that this had not been the case, and that to the contrary, the quality received from the last station was equal to that broadcast from the first station!

Usually when you make a reproduction and then on top of this another reproduction of the previous one, the quality begins to suffer. It is as if you took a phonograph record and from this reproduced another phonograph record and from the result of the last one, made a new reproduction. In this manner it is well known that the defects of each reproduction are passed on to the next reproduction and if there are sufficient reproductions, the end result is poor.

With frequency modulation, however, the reason that we can pile one rebroadcast on top of another rebroadcast is, that in the normal broadcast of this type we have sound fidelity of an unusually high quality and no disturbances to start with. We have no extraneous noises of any kind and, therefore, the 2nd rebroadcast will not have any less fidelity nor any more static than the 1st, etc.

For this reason, unbelievable as it may seem, the end result is so good that you can not tell it from the original broadcast.

You will say that in linked rebroadcasts of this type, tube noises and other noises will no doubt creep in. This, however, is not the case because the tube noises do not reach the program at all and, therefore, are not rebroadcast.

It would seem that Radio is in for a complete revolution, from broadcasting itself, down to the receiver, during the next few years. There seems to be good reason, too, to believe that the radio chains will soon be free from the wire links to which they have been tied for some 20 years.

THE RADIO

WAR NEWS

ALTHOUGH war has put a quietus on European ham-radio, a few German amateur stations have purposely been permitted to keep on operating in the hope of picking up useful information, columnist John Chapman reported last month in his "Mainly About Manhattan."

A mystery broadcast station, purportedly "official British", and broadcasting extravagant claims of British support during the invasion of Poland, was in reality a masquerading Nazi transmitter, claims London, according to columnist Leonard Carlton, last month.

BROADCASTING

STATION WMCA is slated to be the New York outlet of the newly formed Trans-Continental Broadcasting System. This 100-station, coast-to-coast net will have headquarters on 3 floors at 570 Lexington Ave., N.Y.C. Net gets first airing Jan. 1, 1940, Elliott Roosevelt announced last month.

SOUND

"**I** HEARTILY endorse the widespread use of the radio," stated Dr. Alfred L. Kruger, in a medical journal last month. The item that aroused Dr. Kruger's enthusiasm was the 4-channel radio installation in Hudson County Tuberculosis Hospital, Jersey City, N. J. Medical Director B. S. Pollak, M.D., at the Hospital, advises *Radio-Craft* that 600 patients are able to enjoy radio reception by means of individual, earphone-equipped sponge-rubber pillows. The effect upon patients has been encouraging.

It was reported in the *New York Sun*, last month, that sound waves will detonate the magnetic mines which German planes dropped in British waters last month.

Special temporary authority was granted to the National Broadcasting Co., by the F.C.C., last month, to operate Relay



MISS "WEather 6-1212" . . .

The dulcet tones of the young lady in center-foreground may be heard, by proxy, by dialing the above telephone number; "Weather Forecast Information Service" will then come in on the wire and inform metropolitan New Yorkers as to just what is Uncle Sam's official forecast of forthcoming weather. Teletypewriter (right) supplies this data to young lady, at Control Turret (left), who reads the data into the mike for recording on endless steel-tape in a machine 10 stories below (see photo, below.) Reports automatically repeat.

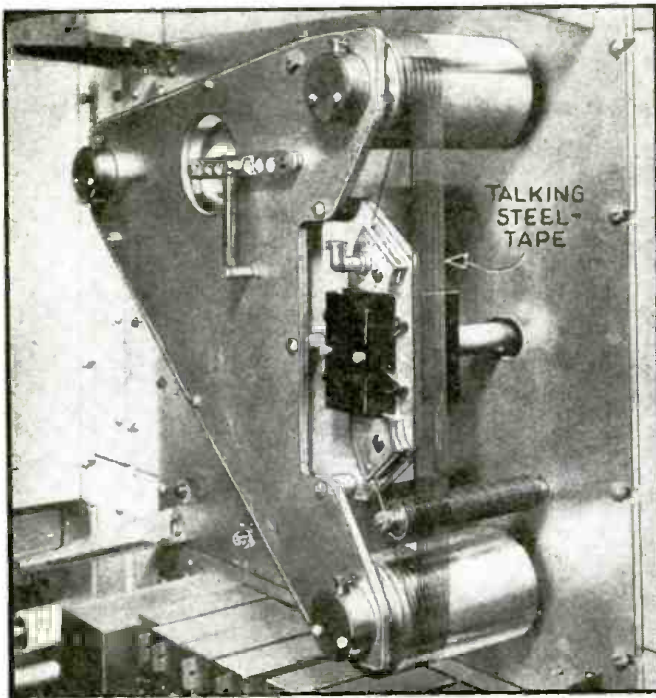

. . . AND THE "WEATHER" MACHINE

Above is a close-up of the recording and reproducing machine used to announce the weather forecasts. Recordings on the steel tape remain until electrically "erased," and a new recording made. (See "Sound-on-Wire Tape," *Radio-Craft*, May 1939, for discussion of general principle involved.) Last month *Bell Laboratories Record* (Nov., 1939, issue) published complete details of this system in the articles, "Weather by Telephone," and "Weather-Announcing Tape Machine."

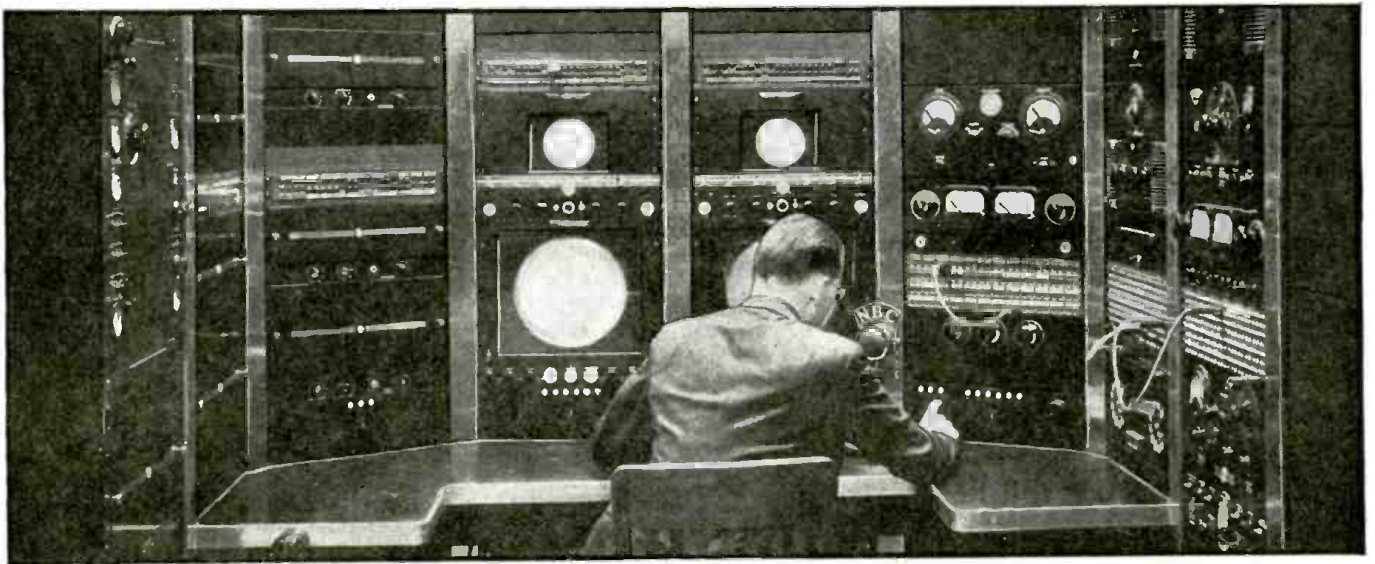

TELEVISION CONTROL ROOM

Last month the National Broadcasting Co. completed the installation of the latest type of television control equipment at its pioneer Station W2XBS, Empire State Tower, New York City; the new telly transmitter control room is shown above. New 12-inch monitor kinescopes and the latest type wide-band oscilloscopes, are a feature of the installation. The new VU volume level indicators and testing equipment for telly's hi-fi sound occupy the panel directly to the right of the monitoring kinescopes. The ultra-shortwave receiver, linking the transmitter with N.B.C.'s tele-mobile field units, is located in the far left panel. This control equipment, designed for extreme convenience, is mounted in a room completely screened to prevent outside interference.

MONTH IN REVIEW

Broadcast stations WEJI and WEJL as Public Address Relay stations in feeding the public address system in the auditorium, from points in the arena not accessible to wireline service, in connection with the National Horse Show held in Madison Square Garden. (Shades of "Wireless Public Address," *Radio-Craft*, Jan. 1940!)

Guy S. Cornish, Cincinnati, Ohio, last month asked the F.C.C. to let him put up 5-watt xmitters on 305, 310, 315, and 325 mc., and a 1-watt station on 310 mc., for public address service.

FM TRIPLE-PLAY

RADIO program reception virtually without static, fading or distortion, in a "radio triple-play" multiple broadcast, became an actuality last month when frequency-modulated transmission from New York City to Meriden, Conn., was demonstrated. Here's how the program traveled: Yonkers, N. Y. (W2XCR), to Alpine, N. J. (W2XMN), to Meriden, Conn. (W1XPW, which is the "F.M." station for WDRG in Meriden). This department's old friend, K. B. Warner, Managing Secretary of the American Radio Relay League, reported reception as better when thus F.M.-relayed than equivalent amplitude-modulated programs without relays!

TELEVISION

"ROLLING REPORTER," writing in John F. Rider's *Successful Servicing*, last month, reported that Italian engineers have installed television receiving and transmitting equip-

ment in an airplane, and have succeeded in transmitting from the plane, images that were so clear as to enable the make of a car, traveling on the ground, to be recognized, at the third corner of the triangle (auto, to receiver and xmitter in plane, to receiver on ground)!

Stated U. A. Sanabria, chief of staff of the American Television Institute, last month: if the television industry grows to a point where 2,000 transmitters serve population centers, telly employment would total 1,000,000 persons directly, and 5,000,000 indirectly.

F.C.C.

LAST month the Federal Communications Commission reported its activities as follows. Television.—*W9XUI, University of Iowa, Iowa City, Iowa*; applied for change in frequency to 50-56 mc. . . . *R. B. Eaton, Des Moines, Iowa*; applied for permit to put up a 100-W. telly station on 44-50 mc. . . . *W'DRC, Inc., Meriden, Conn.*; wants to park a telly xmitter on peak of West Peak, Meriden, Conn., to feed a 66-72 mc. signal to lookers and listeners. . . . *Columbia Broadcasting System, Inc., N. Y. C.*; plans modifications of its telly xmitter, W2XAB, on 50-56 mc. . . . *The Crosley Corp., Cincinnati, Ohio*; wants to get on the handwagon with a 50-56 mc. telly unit, on the 48th floor of the Carew Tower, outputting 1 kw. . . . *Henry Joseph Walczak, Springfield, Mass.*; has asked leave to put a 250-watt telly station on the air—on 1,550 kc.! Address: 360 Worthington St., Springfield, Mass.

Frequency Modulation. — *The May Department Stores Co., Los Angeles*, (Continued on page 493)

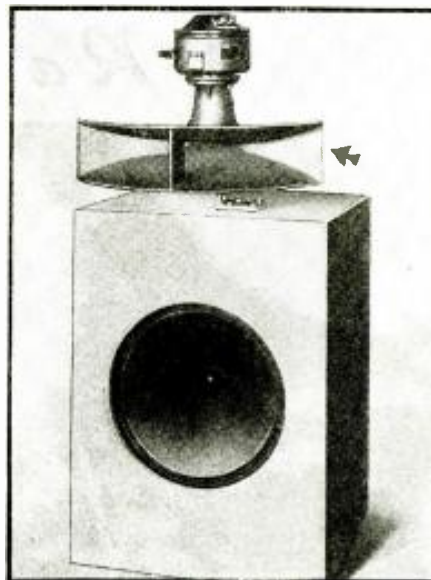

NEWEST "TWEETER"

A single horn which does the work of 4 trumpet-type loudspeakers in distributing upper-register sound was announced last month by the Western Electric Co. This new 31A horn is here shown (arrow) mounted atop a conventional bass unit to form a 2-way hi-fi loudspeaker system. Response of this "tweeter" is 400 to 10,000 cy. Novel shape affects wide sound-distribution horizontally.



\$1,000 RADIO SCHOLARSHIP

A 2-year scholarship in radio technology will be awarded in the Spring, to graduating Seniors who are members of The American Institute of Science and Engineering Clubs. *Radio-Craft* was informed last month, this Marconi Memorial Scholarship, awarded annually by the Veteran Wireless Operators' Assoc. for study at RCA Institutes, Inc., requires: 1 1/2 yrs. of algebra, 1 yr. of geometry and 1 yr. of physics.

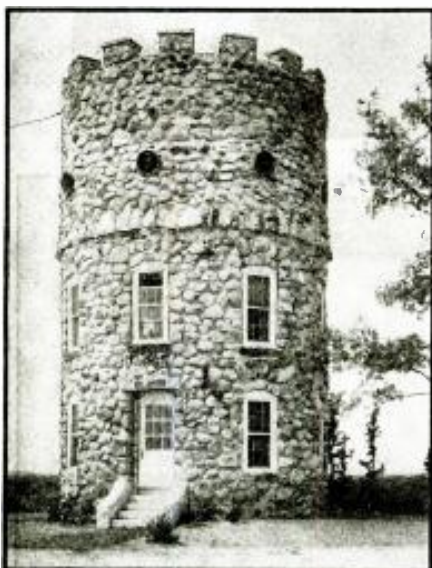

HAM PARADISE!—AND NEW HOME OF THE MANCHESTER RADIO CLUB W1LVK (75 METERS)

Exterior and interior views of this licensed radio amateurs' station deluxe, Smyth Observatory, are shown above. We see Mr. J. Brodie Smith, W1HPM, receiving, in the sumptuous Radio Operating Room on the 2nd floor. The Observatory, erected in 1888, and the 11-acre Park in which it is located, were presented to the City of Manchester, N. H., last month, after being rehabilitated by the W.P.A. This stone "hermitage" is 20 ft. inside diameter and about 40 ft. high. It will be used as part of a state-wide emergency radio network. Equipment includes a gasoline-driven 3 kw., 120 V. emergency power supply unit; Hallicrafters HT-4 transmitter; Hammarlund HQ-120-X receiver, and other ham-radio gear.

Radio Pictorial



RADIO ANTENNA

FIGHTING FIRE

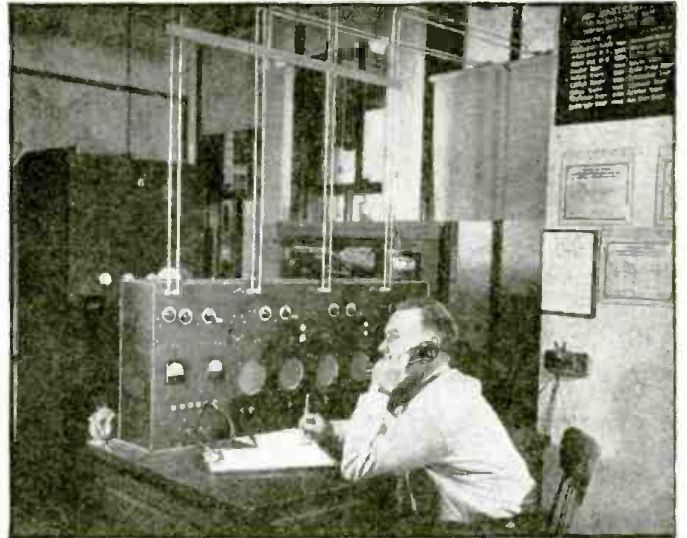

WITH RADIO!

The New Jersey Forest Fire Service is the most extensive fire-control unit of its kind in the United States, with its widespread patrol units and facilities for protecting 3,000,000 sq. mi. of wooded land being instantaneously interlinked by means of 2-way radio. Forty section wardens, and 375 district fire wardens, are coordinated in their work by radio. All patrol cars and fire-

fighting trucks as well as the Service's patrol plane report to the nearest district warden at the first sign of forest fires. Fire trucks are then immediately ordered by radio to strategic points. Above, l., one of the radio-equipped pumper trucks is shown spraying water from sink holes fed by natural springs. Above, r., Warden Stratton at the main transmitter in Trenton, N. J.



A WAR WITH WORDS

◀ "War communique 4X924, morning.—Terrific sound bombardment by the enemy in Mosello sector. Our forces replied in kind."—This fictitious communique might well be real for all the lack of actual fighting at the Western Front. It seems as though more words than bullets are flying over No Man's Land. "We won't fight if you won't fight," say the wily Germans. "If you don't do something pretty soon, we'll have to find someone else to fight," reply the French—and so the war goes on. Along the Rhine, batteries of loudspeakers like this one daily assail French soldiers with a verbal barrage.

(Photo—Int'l. News)

LARYNX MIKE

▶ An English "Spotter" using his Range Finder for detecting approaching enemy aircraft and at the same time relaying the range data to the gunners by way of his throat (larynx) mike. This mike enables the man to talk while operating the range finder and at the same time be free from concentrating on a mouth-type mike. The larynx mike is pressed against the throat and the voice transmitted by the latter's vibration. The U. S. Army and Air Corps use similar-type mikes.

(Photo—Int'l. News)

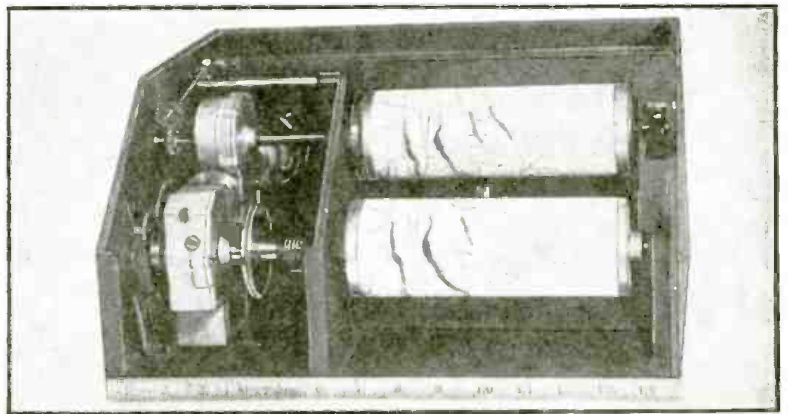
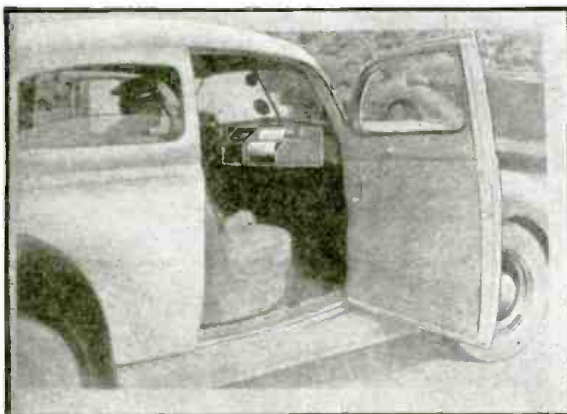

2-WAY RADIO FACSIMILE IN AUTOMOBILE

The new Finch system of facsimile transmission is constantly finding new and important applications. A 25-lb. transmitting unit in an observation plane over enemy lines is now able to transmit back to headquarters or gun batteries the locations of troop concentrations. Police squad cars now contain 2-way facsimile units, as shown above, over which not only written orders can be sent and

received but photographs of wanted criminals, fingerprint charts, and the like. While transmitting from a car the receiver unit acts as a monitor! Above, right, is shown the actual instrument. It handles 2-way simultaneous communication on the same channel. Top cylinder is for transmission, lower one for recording. Paper sheets are 8x7 ins. Speed, 8 sq. ins. per min.

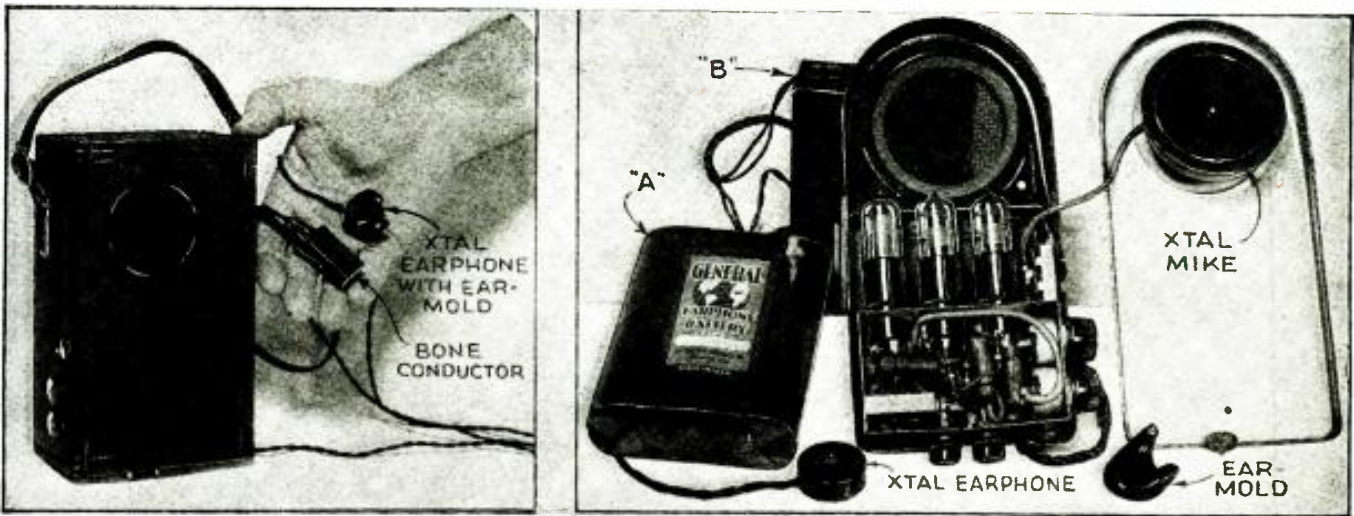

The leather case shown above houses the crystal (xtal) microphone, A.F. amplifier, and "A" and "B" batteries shown in the second illustration at right.

3-TUBE ULTRA-COMPACT DEAF-AID

Radio Servicemen will be required to keep in proper operating order the new and increasingly large number of tube-type hearing-aids which are making their appearance on the market. The Crystalear, as a representative make of these new devices, is here described and diagrammed.

THE diminutive A.F. amplifier which an imported and a domestic make of midget battery tube recently made possible has found commercial application in the Crystalear model 39BW hearing-aid here illustrated. An important advantage which tube-type hearing-aids have over other types is that practically unlimited amplification is available for use in correcting deficiencies in any part of the audio spectrum. This frequently results in very satisfactory hearing which previously was unattainable.

The hiss of carbon microphones operated at the extreme sensitivities ordinarily required in use as a hearing-aid has been eliminated by means of the Rochelle salt or crystal microphone. This mike feeds a tube-type amplifier of high gain, the output of which is connected to a high-fidelity crystal earphone. (An all-crystal hearing-aid of larger proportions was described in *Radio-Craft* over a year ago.)*

The instrument and battery may be concealed on the person or they may be fitted into an accessory leather case as shown at left in the photograph. To wear the instrument it is only necessary to remove the batteries and hearing-aid from the case, place the batteries in a convenient pocket and support the instrument with a small cord worn around the neck. As to the earphone, the manufacturer makes available a chart which illustrates 5 sizes of ear-molds for the left ear and 5 sizes for the right ear in order to make proper fittings by mail.

Other features of this wearable instrument are the following:

- (1) Uses new low-drain tubes.
- (2) Has exceptionally low "A" and "B" current drain.
- (3) Has removable sockets for replacing tubes.
- (4) Employs both crystal microphone and crystal earphone.
- (5) Is highly non-directional.
- (6) Has a "Frequency Compensator" to provide complete adjustment in high, medium, and low frequencies.

- (3) Has removable sockets for replacing tubes.
 (4) Employs both crystal microphone and crystal earphone.
 (5) Is highly non-directional.
 (6) Has a "Frequency Compensator" to provide complete adjustment in high, medium, and low frequencies.

TECHNICAL DETAILS

This hearing-aid is designed to operate on batteries as originally furnished with the instrument. The plate drain is 1.5 ma. The filament drain is 50 ma. Replacement batteries which will fit into the available space are: one 4½-V. "General Earphone Battery" (General Dry Batteries, Inc.), No. 271; and, one 45 V. "General Radio 'B' Battery," No. V-30-AAA, which has a tap at 22½-V. The "B" battery will give approx. 150

hours of service at the rated current drain of less than 1½ milliamperes. The "A" battery will last approx. 75 hours at the rated current drain of less than 50 ma. at 4½ volts.

Checking these figures against the ratings of the batteries it will be found that the 2 "A" batteries and 1 "B" battery furnished with the original instrument may be used in such way as to have uniform life. The procedure of alternating the use of the "A" batteries—that is, using one "A" battery one day with the "B" battery and the other "A" battery on the second day, and continuing to alternate in this manner—if followed, will result in the two "A" batteries and the "B" battery becoming exhausted at the same time. Servicemen should point this out to customers.

The tubes are standard Hytron models, (Continued on page 496)

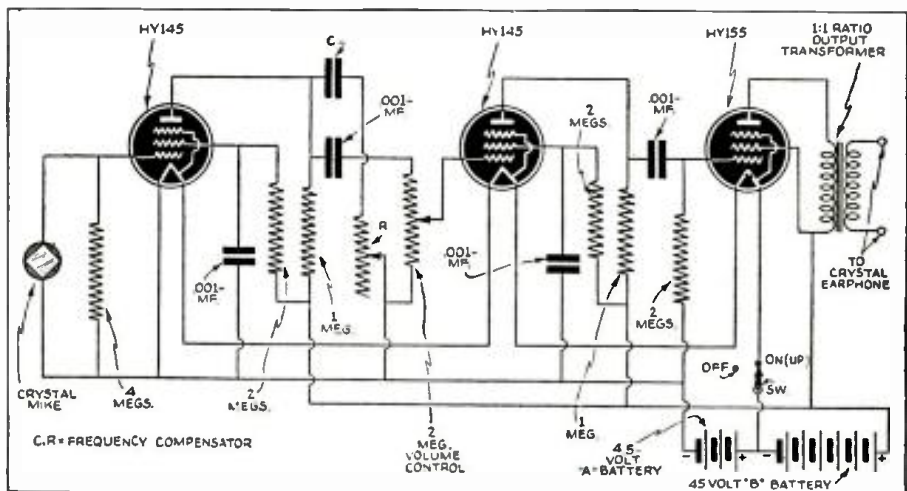

Schematic circuit of the Crystalear model 39BW deaf-aid. It utilizes new types of Hytron miniature tubes.

*"New High-Fidelity Hearing Aids," Oct. 1938.

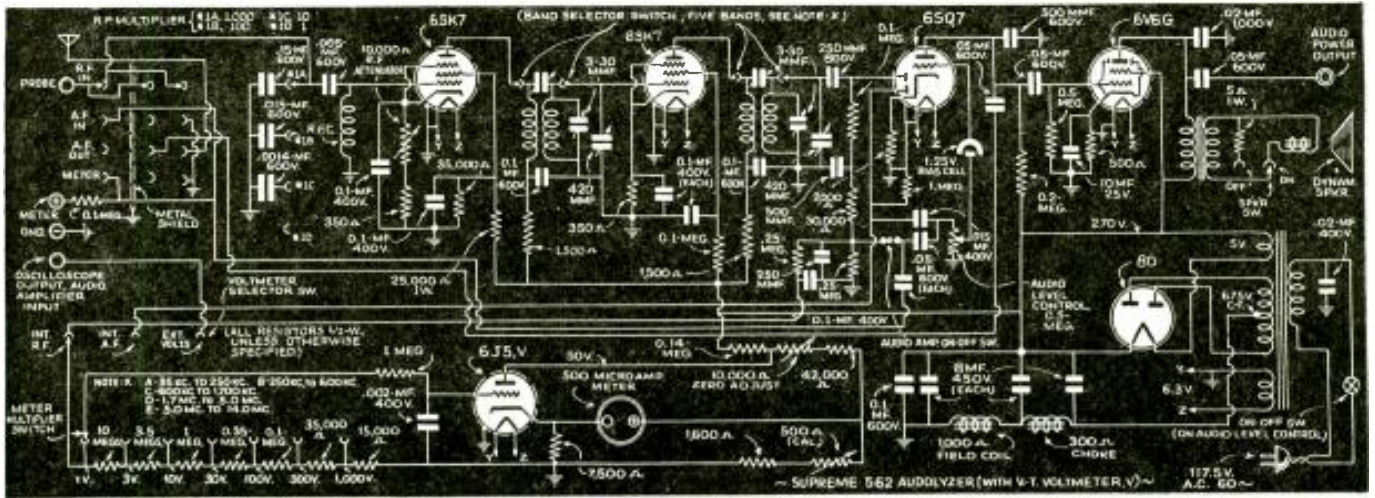

RECENT TEST EQUIPMENT

A group of 3 instruments has been selected for description this month as being representative of the new test equipment which engineers have devised to make the radio Serviceman's job easier.

N. H. LESSEM



Supreme

THE basic principles of testing have changed little over a period of many years. However there has been rapid development in the actual application of these principles to the requirements of test equipment for use in all phases of radio. For instance during recent months there has been introduced a number of improved test instruments having facilities previously unavailable. Of these widely differing types of instruments, 3, selected at random, are the following:

- (1) Dynamic Tester (with Vacuum-Tube Voltmeter)
- (2) Oscilloscope Wobbler
- (3) Inductance and Capacity Checker

As the manufacturers of these devices will supply extensive, detailed information regarding the use of the specific instruments we will limit ourselves to describing the points of major interest; and to using in illustration only the respective photo and diagram.

Supreme Model 562 Audolyzer. Dynamic or "action" testing which has been used for some time in its mechanical form in the dynamic balancing of wheels and other parts in automobile factories, has been applied electrically to the testing of radio receivers in use, as described in recent issues of *Radio-Craft*. The Audolyzer shown here, although designed to meet this technique of dynamic testing, is applied in a particular manner which is best described as "signal checking"—in contrast with "dynamic testing" in which, in addition, an oscilloscope is used.

As has been pointed out in recent issues of *Radio-Craft* the process of tracing a radio signal from antenna to loudspeaker through a set which is defective may be made by either audio or visual means; and the signal may be a broadcast program or the output of a servicing signal generator. The Audolyzer employs audio analyzing for checking, on a loudspeaker built into the unit (as compared to other instruments using visual analysis which may require reference to either tuning eyes or meters); and ordinarily utilizes as the signal source any broadcast program which will actuate the receiver under test (although,

the A.F.-modulated R.F. output of a signal generator may be used, if desired).

Referring to the wiring diagram, with "Probe" in the "R.F. In" position, the signal is fed into the 1st stage of the tuned 6SK7 amplifier. Here the level of the signal may be controlled with the R.F. multiplier and the R.F. attenuator. The R.F. amplifier is tuned over a range of 95 kc. to 14.5 mc., covered by 5 overlapping bands. From an input stage it is again amplified by a 2nd 6SK7 tuned amplifier and then is detected by the triode section of a 6SQ7. The triode section of the 6SQ7 is used as a driver stage for the 6V6 which in turn drives a 5-in. dynamic speaker. Thus the 2 tuned R.F. stages followed by a detector and 2 A.F. amplifiers, provide enough gain to handle the lowest signal found in a normal test procedure. If the signal level is high, the "Multiplier Switch" keeps the input down in order that the 1st 6SK7 will not be overlooked. The frequency range is wide enough to cover I.F.'s, oscillator and R.F. signals found in commercial household radio receivers. The probe does not detune any circuits. The dial is accurately calibrated and the tuning condenser has a vernier drive for easy tuning.

The signal level in the audio circuit is controlled by the "Audio Level" or gain potentiometer. Thus facilities are provided for a separate control of signal level passing through the R.F. circuits or the audio circuits of the Audolyzer.

Note the switching of the probe: In the "R.F. In" position, any R.F. signal from 95 kc. to 14.5 mc. is picked up and fed into the R.F. amplifier; in the "A.F. In" position the same probe can be used to feed an audio signal into the A.F. amplifier whose gain is continuously variable; in the "A.F. Out" position the audio circuit of the Audolyzer is available on the probe (a most convenient signal to have to test audio circuits); in the "Meter" position the vacuum-tube voltmeter is switched across the probe. Thus with the 1 probe, every type of signal present in a receiver can be analyzed. This is a big time saver when 1 probe can be used for all the various tests.

Vacuum-Tube Voltmeter. The vacuum-tube voltmeter included in the Audolyzer permits checking, to determine whether all the D.C. voltages are correct, without disturbing the normal operation of the receiver. This is made possible by the 15-meg. input sensitivity of the instrument for the 7 D.C. ranges of 0/1/3/10/30/100/300/1,000 V. The center-

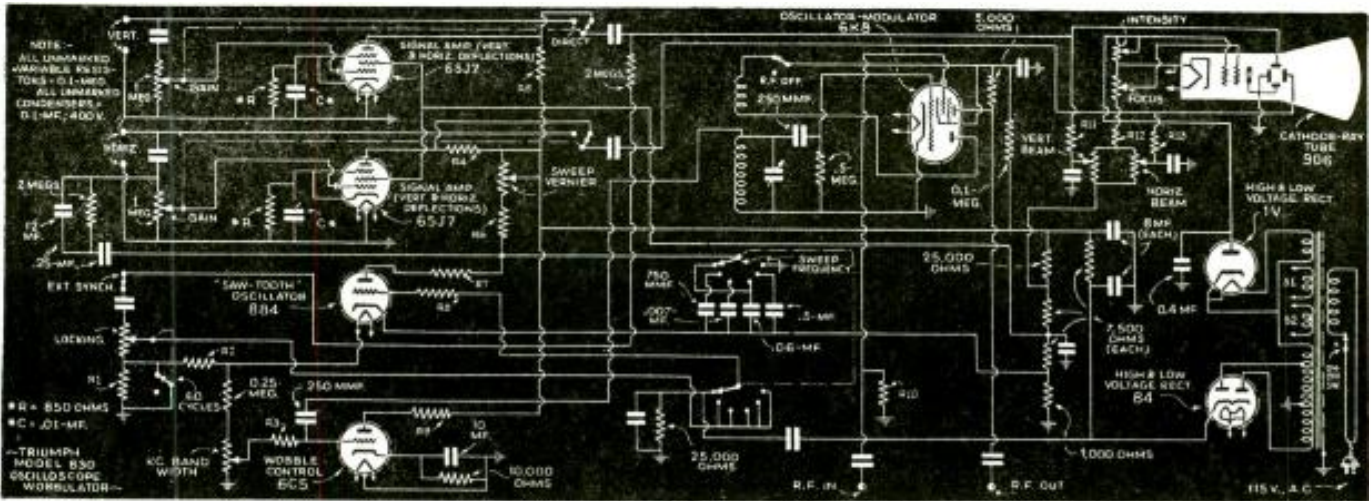

reading meter indicates on either polarity without shifting test leads.

The V.T.-VM. also permits convenient check of the receiver's oscillator. The procedure is to probe at the oscillator's output and watch the meter. If the oscillator cuts out or is weak over any portion of its range this immediately shows up as a change in the meter's indication.

Many sets have oscillator trouble where the coil changes inductance. Sometimes this changes the resulting variable frequency band sufficiently to not allow the oscillator trimmer and padder condensers to pull the oscillator into line for a predetermined I.F.

Checking Frequency. To determine the unknown frequency to which any receiver circuit is tuned—oscillator, I.F., or R.F., just use the tuning portion of the Audolyzer in connection with its V.T.-VM. as a frequency meter. For the receiver's oscillator, place the probe on the oscillator output and tune the Audolyzer for the greatest swing of the meter. Then read the frequency on the instrument's direct-reading dial.

For R.F. determination, the Serviceman's signal generator is connected to the receiver's input and the Audolyzer probe is placed on the output of the R.F. stage under test. The signal generator and Audolyzer are then adjusted to the same frequency. The next step is to adjust the receiver dial for maximum swing of the Audolyzer's meter needle. Finally, the receiver trimmer is adjusted until the receiver dial reads correctly.

To determine the actual signal being fed to the I.F. stages, the probe of the Audolyzer is connected to the 1st-detector output, a signal is fed into the receiver, and the Audolyzer dial adjusted until maximum swing of the meter needle is secured. The actual I.F. signal's frequency may then be read on the dial! Note that in none of these tests will the receiver be detuned by the application of the probe.

The V.-T. VM. in this instrument is also suitable for making gain measurements on R.F. and A.F. circuits.

Triumph Model 830 Oscilloscope Wobbler. Said to be the smallest 3-in. oscilloscope made, the C.-R. instrument here shown nevertheless incorporates the following features:

Oscilloscope with variable band-width and automatically synchronized electronic-type frequency-modulated wobbler on a fundamental of 1,000 kc. Horizontal and vertical 6SJ7 ultra-modern plate deflection amplifiers with 10 to 100,000 cycle response. Thyatron linear timing switch with range of 7 to 30,000 cycles. An exceptional input sensitivity of 0.4-V. per inch deflection.

This unit has all the regular oscilloscope controls, plus band-width; and by combining the functions of a wobbler and oscilloscope in one instrument makes it convenient to use the model 830 instrument in the following services: V.-T. voltmeter, frequency analyzer, A.C. meter, power factor indicator, amplifier, harmonic analyzer, modulation meter, distortion indicator, in laboratory bridge measurements, as a sensitive A.C. galvanometer.

Combined with the wobbler it becomes a qualitative A.F. response analyzer and a sensitive resonance indicator for tuned I.F. and R.F. circuits. With the combination oscillo-

scope and wobbler, A.F.C., oscillator and hi-fi circuits may be correctly adjusted. Without opening circuits all leaky condensers, imperfect resistors, under-coupled coils, insufficient shielding, regeneration and oscillation may be detected. Defective circuit components such as condensers and transformers may be checked without removing them from the circuit.

Additional characteristics of the model 830 wobbler - oscilloscope are as follows: Frequency range over timing axis up to 30,000 cycles; deflection sensitivity at C.-R. tube inputs, 18 V. per inch; maximum D.C. across input binding posts, 400 V.; band-width of wobbler, 0-50 kc.; single or double wobbler trace, sine waveform; 60-cycle sweep for single-trace wobble.

Aerovox 95 Electronic L-C (Inductance - Capacity) Checker. It is important to test or check radio components and circuits at their operating frequencies. For example, condensers (C) tested at A.F. may exhibit good characteristics and yet fail to function properly if used in R.F. circuits. Again, coils which act as inductances (L) at audio and low radio frequencies may act as condensers at certain higher radio frequencies. The L-C Checker here illustrated makes it possible to determine the effectiveness of a condenser or inductance while it is connected to its circuit.

This instrument comprises an oscillator covering 60 kc. to 26 mc. in 6 coil ranges, together with a frequency-matching indicator. The coil ranges are selected by the coil-range
(Continued on page 503)

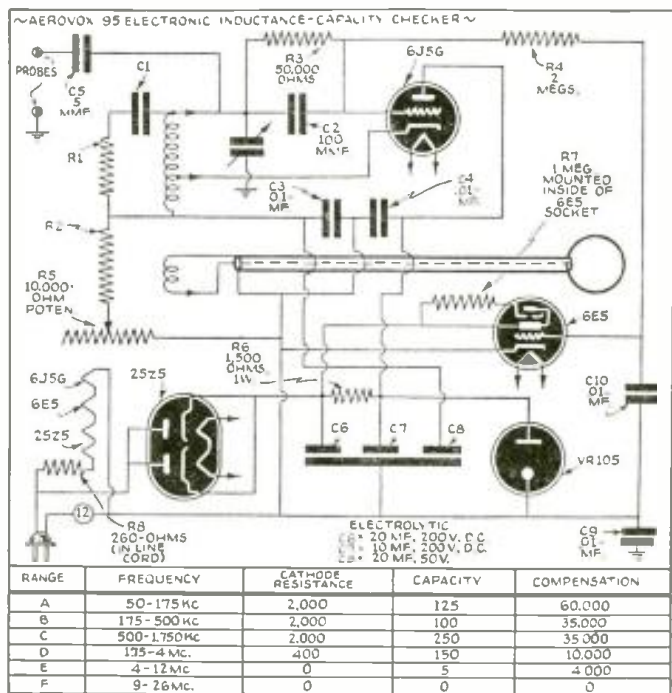

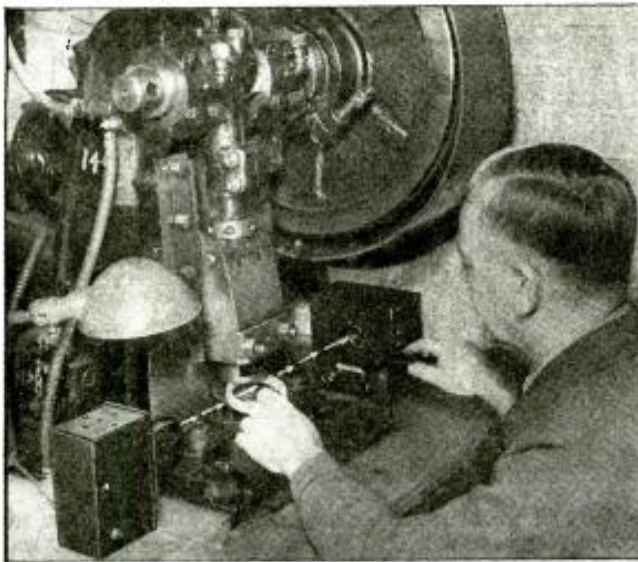

These photos illustrate but 2 of the thousands of industrial applications for photoelectric equipment. The illustration at the left shows photoelectric equipment used to assure the safety of the operator of a heavy punch-press. The illustration at the right shows the same photoelectric equipment, here used to count radio speakers as they pass along on an endless belt.

Selling and Installing "Electric Eye" Equipment

Photoelectric or "electric eye" equipment can be adapted by Servicemen for many versatile uses in the home, factory, office, or outdoors. Photocell equipment is used daily to reduce cost of operation, speed up work, eliminate hazards, and serves in many additional capacities not adaptable to other forms of control.

M. N. BEITMAN

THE market for photocell equipment has been barely scratched, and new uses are found daily. The mysteriously swinging doors, automatic sorting devices, punch presses, safety cut-outs, burglar alarms, smoke controls, are just a few applications which recall the multitude of needs for photocell equipment. Photocell equipment is also used for color matching, comparing opacity of material, window light control, and highway speed timing.

With this gigantic market needing suitable photocell installations, there is today but a handful of companies and individuals selling and installing this type of equipment. There is little attempt to publicize the uses and need for photocell devices because the natural demand is sufficiently large to keep all engaged in this profitable business working overtime.

You, as a Serviceman, must have been looking for something relating to your work which would add a few dollars to your weekly income. Photocell sales and service offer just this, and with production units selling at very low prices, you really can make a worthwhile profit. The public is ready to pay a fair price for a good photocell installation, and there is no competition from the unqualified radio experimenter and student. For the aggressive Serviceman this vast field of opportunity is a "natural."

PRACTICAL INSTALLATIONS

Let us consider a few exact uses for photocell equipment so that you will be in a better position to judge where demonstrations should be made. Commonly a simple photocell relay is used to turn on lights at dusk and possibly turn these lights off after daybreak. Since sundown time changes each day, this type of installation will insure correct time for switching on the lights and will prevent waste of electrical power.

When improper combustion occurs, excessive smoke is present. By placing a photocell relay and a light source facing each other in a chimney, excessive smoke can be instantly detected, and associated equipment used to adjust the furnace.

Another application exists in a restaurant which has several tables placed near the wall. A narrow beam of light is passed parallel with the wall about 30 inches above the table-top. At one end the beam strikes the lens of a photocell unit. Any person sitting at one of these tables merely raises his hand and thereby interrupts the beam of light. This causes an alarm bulb to flash and inform the waiter that he is needed at one of the tables.

A versatile radio man can think of hundreds of applications especially adaptable to the community he serves.

The radio Serviceman is the logical individual to serve in the capacity of photocell expert, and the need is so large that a little publicity will bring loads of "money-making" business.

"ELECTRIC EYE" DEMONSTRATOR

The way to any sale is to *make a demonstration*. You should, therefore, secure a simple photocell relay and a suitable light source. There are, of course, many special units designed for unusual requirements, but even the simplest photocell relay will demonstrate the effectiveness and principle of the future installations. The regular light source will serve, but infra-red light can be planned for the final installation.

A simple photocell relay consists of a sensitive photocell connected to the control circuit of a high-gain vacuum tube. The output of this tube is used to operate a relay which, in turn, opens and closes the contact used for controlling associated equipment.

Since in the majority of applications abrupt changes of light are used to operate the photocell, this device need not be too sensitive and can be obtained at a very reasonable cost. However, in installations where color sorting or other critical applications must be handled, the photocell must be of the highest sensitivity and accuracy.

The reason the amplification of a

vacuum tube is required is due to the small amount of current passed by the photocell and the larger current required for proper operation of the relay unit. The vacuum tube amplifies any changes of light intensity placed on the photocell.

The photocell can be connected to the amplifying tube in several different ways, and the circuit can be so adjusted that an increase in light will either open or close the relay.

Previous articles have been published in this magazine on photocell operation. Meanwhile, assistance in selecting the proper equipment for any installation can be secured from the manufacturers and jobbers selling devices of this type.

The job of selling photocell equipment is relatively simple since once you can call the attention of any firm to the need of such equipment in their particular business, the sale will be made without further complications.

If you will review the different factories and offices operating in your city or nearby, you will realize that many excellent opportunities for merchandising photocell equipment exist. Simply call on these companies with your demonstration unit, and show the purchasing agent of the firm how photocell equipment can be used in the particular business to save time or for other applications.

If you have printed stationery, you should include on your letterhead, and other pieces of literature describing your business, the fact that you are a specialist in photocell work and can make complete installations for all applications. A mere mention of this fact will, in many instances, bring one installation job per week.

If you are operating a radio store, use photocell equipment in your window for starting a motivated display or for turning on and off the electric lights. This is sure to attract attention to your window, and besides, promote the sale of photocell devices.

Many times excellent opportunities exist for tying-in with local news events. For example, if a robbery occurs in the neighborhood you serve, you can mention in your advertisement that the use of photocell devices will entirely eliminate the possibility of such robbery recurring.

Assuming that you will be able to

follow these suggestions on your own initiative and make the sale, you will also want to know something about the installation and placement of the photocell unit and the light source for different purposes.

PRACTICAL ELECTRONICS

You must bear in mind that the distance covered by any photocell installation depends upon the power of the light source, the sensitivity of the relay and the light conditions present. At all times, in a darker place, a given amount of light and a definite type of photocell unit will operate over a much longer distance. The presence of stray light or a strong illumination will considerably decrease the sensitivity of the equipment.

Several interesting photocell installation lay-outs are illustrated and will help you to design installations for your own requirements. Notice that the light can be directed at the photocell unit, or it can be reflected at several angles by means of mirrors. The angle formed by these beams of light striking the mirror, and being reflected, should never be greater than 90 degrees for best results.

In making photocell installations care must be exercised to make the installation of a permanent nature and save yourself adjustments and repair jobs later on.

Besides receiving orders for new photocell installations, you will be called at times to service equipment already in application. Since the circuits used in photocell equipment are relatively simple, only a few parts can actually go out of order and cause any difficulty. Routine tests suggested below ordinarily detect the fault existing.

SERVICING "ELECTRIC EYE" UNITS

Place any suitable light source near the photocell relay, and turn the sensitivity adjustment until the relay just clicks. Now back up with the control until the relay is returned to its natural position. The removal of light should immediately cause the relay to click again. This test, of course, is performed on the type of photocell relay which has its circuit adjusted to close the relay with a decrease of light. For such photocell units which have their operation adjusted for closing the circuit with an increase of light, the same test should

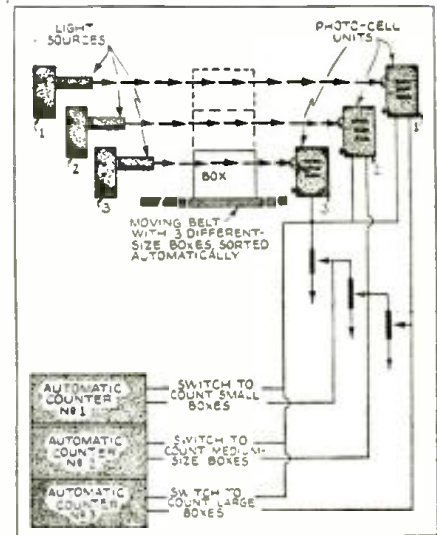

Block diagram showing the use of photoelectric equipment in counting 3 different sizes of boxes (or any other products) as they move along an endless belt on the production line. Three separate light sources, photoelectric cells and automatic counters are used

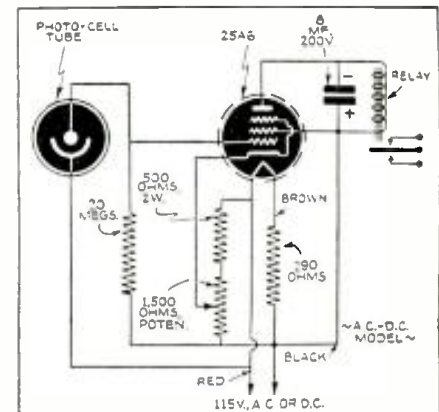

Schematic diagram of a typical photoelectric circuit and its vacuum-tube amplifier. This circuit is energized from the 115-V. line, A.C. or D.C.

be performed in darkness, whereupon flashing a light on the photocell will cause operation.

If too much light change is needed to cause the operation, probably the difficulty lies in the photocell or the amplifying tube, and these should be replaced as a test. If no operation at all is obtained, the power is not coming from the line; or some resistor or other associated part of the circuit is at fault. Since only one

(Continued on page 496)

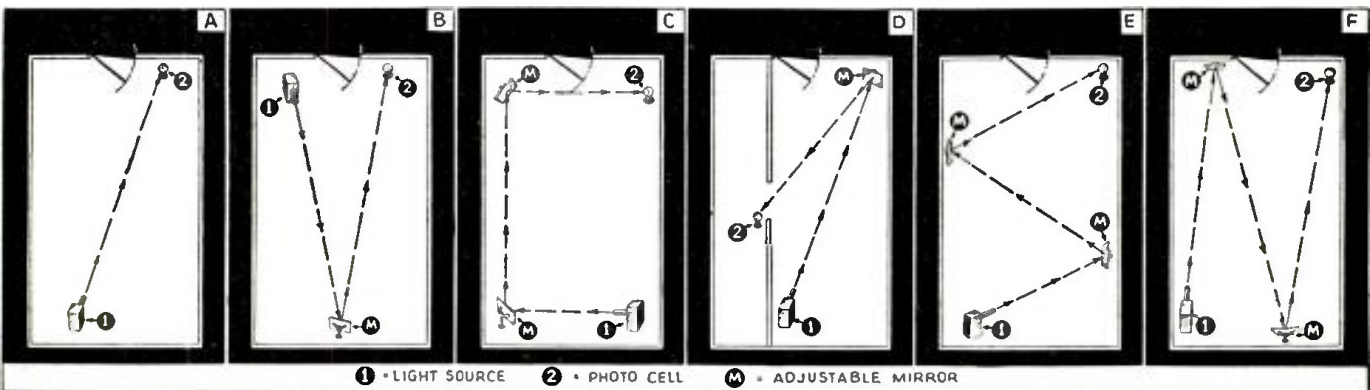

These are typical layouts for installing photoelectric equipment as burglar alarms. The beam of light goes from the light source (1), to the photocell (2), either directly (as shown in A) or after being reflected from one or more mirrors (M).

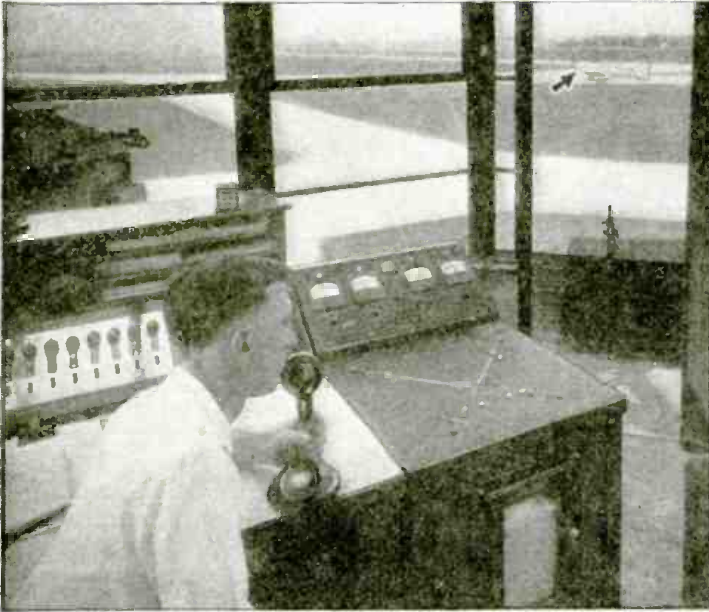

The Monitor and Control Desk for the I.T.&T.-C.A.A. blind-landing system, in the control tower of the Indianapolis Municipal Airport; it is one of the cover photos. Lights, on desk, spot transmitters in use. Various transmitters may be switched into use to suit wind conditions. Aural and visual alarms operate if transmitter outputs drop below normal; or if localizers are causing an off-runway landing.

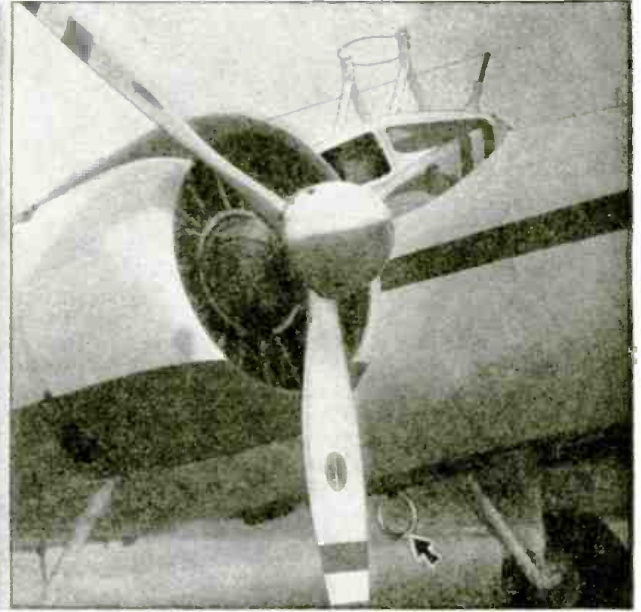

The United Air Lines' "Flight Research" Boeing has a special loop, mounted horizontally atop plane, for receiving the new landing beam. Vertical loop (arrow) receives the standard flight beams.

NEWEST RADIO-DIRECTED

Aviators no longer need depend upon the efficacy of a dab of gum on the guidance, on fields obscured by fog or otherwise exhibiting zero-zero inates the dangers of multiple, bent, or crooked courses, and the effect known

"BLIND LANDING" has reached a new high in safety, it was demonstrated last September* at Indianapolis Municipal Airport, with the introduction of the C.A.A. Aircraft Radio Instrument Landing System.

This system represents the coordinated results of 10 years of intensive research and development in this field both in the United States and in Europe. It is intended to serve as a basis for future installations which the Civil Aeronautics Authority plans to provide at the major airports of the

*The radio instrument landing system demonstrated on September 12-15, 1939, at Indianapolis Municipal Airport, Indianapolis, Indiana, was designed, manufactured and installed under contract to meet the performance specifications of the Civil Aeronautics Authority by International Telephone Development Company, Inc. This Company is a subsidiary of the International Telephone and Telegraph Corporation whose associates have been actively engaged in the development and manufacture of instrument landing equipment since 1929.

United States for the use of the air transport lines and other airplanes properly equipped.

An aircraft radio instrument landing system is an arrangement of radio transmitters the radiations from which are so directed into space as to provide complete guidance to an airplane pilot who finds it necessary to make a landing under conditions of poor visibility. In other words, it is an *inclined radio pathway* from the surface of the airport runway up to an altitude sufficient for the pilot to center on the radio beams and maneuver his ship to a successful landing entirely by instruments.

4 TRANSMITTERS PER DIRECTION

A set of 4 radio transmitters correctly arranged with respect to the landing runway produce the necessary space radiations

for each landing direction. The *runway localizer transmitter*, situated in direct line with and approximately 1,000 feet beyond the far extremity of the runway, provides the course indication or "lateral guidance" for the approaching airplane to insure exact alignment for landing on the runway.

The *glide-path transmitter*, situated to one side of the runway and approximately opposite the far end of the runway, gives the pilot his true line of descent, or "vertical guidance," by which he may glide his plane to a correct landing on the runway. (The illustration directly below shows the effective gliding path which this transmitter produces.)

The 2 *marker transmitters* send radio beams directed sharply upward which indicate to the pilot that he has arrived over certain definite points in his approach to the





Here is shown the entirely new and unique 3-unit antenna installation for the runway localizer transmitters, of the new instrument-landing system, which radiates a horizontally-polarized "left-right" beam.

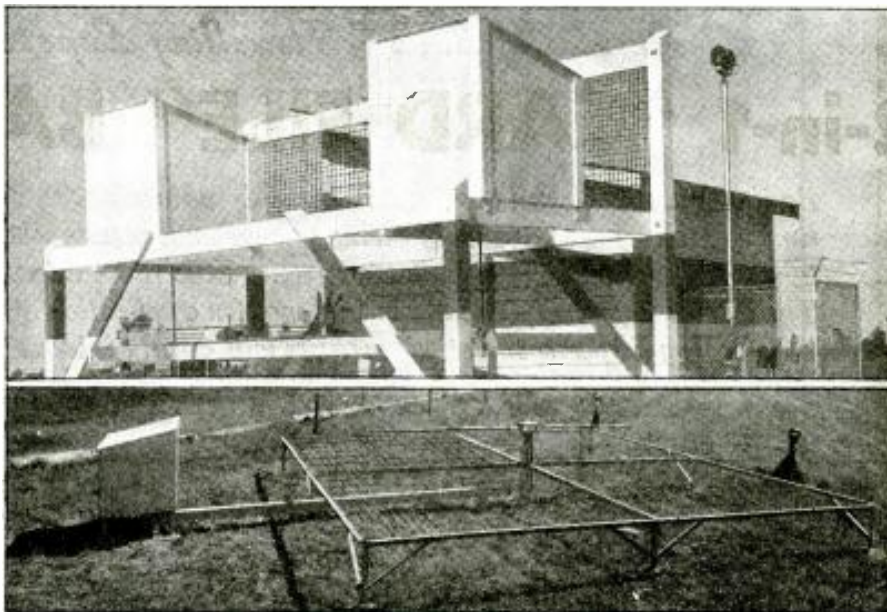

Above—Glide-path transmitter building and antenna set-up which provides beam for straight line of descent from the outer marker, 2 miles from the airport, to the landing runway. Its signals help assure "blind" pilots "happy landings."
Below—Inner marker transmitter at edge of landing field, on course with one of the landing runways.

BLIND-LANDING SYSTEM

fuselage to help assure "happy landings", using only instruments for visibility. A new landing system, using horizontally-polarized waves, eliminates pilots as "pushing the beam." Its technical details are here disclosed.

airport. These are in reality safety check points. The outer marker, situated approximately 2 miles from the airport on the line of approach, advises the pilot where to start his glide. When the pilot, flying at a predetermined altitude meets the glide path at this outer marker, he knows that both the ground equipment and his receiving apparatus are in correct adjustment for him to start his glide on the instruments. The inner marker, situated at the edge of the airport on the line of approach, indicates to the pilot when the plane has cleared the boundary of the field and has reached the area within which it is safe to make wheel contact with the ground.

THE C.A.A. INDIANAPOLIS INSTALLATION

In this Civil Aeronautics Authority installation at Indianapolis, 4 complete groups of instrument landing transmitters have been set up permitting radio landings in any of 4 wind directions: northeast, southeast, southwest and northwest. The group of transmitters for any direction can be turned on from the airport control tower to meet local wind conditions for landing. The airport tower is equipped with an instrument landing control board by which the operator can select directions at will, and the correct operation of the ground equipment is indicated by visual signals on this control board. Should any part of the system fail to operate, the control tower is warned immediately both by visual and aural alarms.

The Civil Aeronautics Authority system was designed to meet a set of performance specifications derived by the Government experts from their intensive study of the principal developments in radio instrument landing in the United States and also outstanding developments in this field in Europe which have been produced by as-

sociated laboratories of the International Telephone and Telegraph Corporation. (*) The C.A.A. officials stated specifically and in detail what they wanted their instrument landing system to do. It was the problem of International Telephone Development Company to design and produce it. This has been done. Indications are that the Indianapolis installation has exceeded expectations in the sharpness of its runway localizer radiation, and it has exceeded expectations also in providing a straight line glide-path which has been developed by I.T.&T. engineers since the contract for this system was awarded.

THE STRAIGHT LINE GLIDE PATH

Aviation has long demanded a glide path which would give a straight line of descent to the field. All systems demonstrated heretofore have provided a curved glide path with a steep drop at the beginning of the descent, flattening out as the runway is approached. This means that the pilot must be continually changing the throttle-setting and correcting the attitude of his ship while following the glide path—all this throughout the brief space of time which he has for the landing operation. Furthermore, the flattening out of the glide path results in a high landing speed.

On a straight line glide path the pilot can set his throttle and the attitude of his ship at the beginning of the glide. Then, he can concentrate completely upon the landing indicator and the small adjustments of his flight controls necessary to center on the localizer and glide-path beams, and following this glide path the pilot brings his ship in a natural descent to the runway.

The I.T.&T. has developed an improved type of glide path which is straight from

*See "Shortwave Radio Lands Army Plane", Radio-Craft, Dec. 1937.

the airport to 600 feet above the outer marker and which, therefore, overcomes many of the difficulties which have existed in the past. From the pilot's standpoint this is one of the most outstanding contributions to instrument landing development since 1929 when the first radio landing system was demonstrated in the United States by the Bureau of Standards.

A SHARP, RELIABLE LOCALIZER BEAM

The success achieved by the I.T.&T. engineers in producing an extremely sharp and stable runway localizer beam is also regarded as an outstanding step forward. Great difficulty has been experienced heretofore in producing a runway localizer transmitter which could be absolutely trusted to be free of multiple courses, crooked or bent courses, and also free of the effect known as "pushing the beam." (In the latter phenomenon the pilot finds that he is able to swing away from the true line of descent and still receive the localizer beam. This "leeway" of course is undesirable.)

In meeting the rigorous C.A.A. requirements, the engineers found the elimination of these difficulties to be one of their most serious problems. Their research determined that pure horizontally-polarized radiation, entirely free of vertically-polarized waves, was essential to overcome the troubles enumerated above.

To satisfy these requirements they developed a new and unique design of basic antenna element. They also devised an arrangement of these elements for controlling reradiation from structures, pole lines, trees, etc., near the airport. The result has been a runway localizer beam which is extremely sharp and consistently reliable. The result has also been a localizer system which provides the pilot with 2 re-

(Continued on page 500)

RADICALLY NEW MINIATURE "Button" Bottom TUBES

1R5 Pentagrid Converter

1S4 Power A.F. Pentode 1S5 Diode Pentode

1T4 Super-Control (Variable-Mu) R.F. Pentode

R. D. WASHBURNE



At last! Miniature tubes not designed for any special purpose! They can be used wherever ordinary-size radio tubes of similar characteristics are employed. The series includes R.F., A.F. and power types.

LAST month RCA announced the first 4 of a series of tubes—of a type popularly called "peanut"-size—that for the first time in the history of commercial tube manufacture, here or abroad, makes possible the construction of efficient radio receivers of tiny proportions; in addition, they may be used, like previously-available miniature tubes, in hearing-aids and other A.F. devices. A *pentagrid converter* is one of the outstandingly new developments in the series. A review of earlier tube developments bearing on the new designs may be of interest. A few references (see end of article) are included in this review, which follows, for such interest or value as they may hold for readers.

CHRONOLOGY

The major limiting factor in small-space receiver design has always been the tubes. With the advent of metal tubes (1), manufacturers for the first time had a real opportunity to go to town in designing small sets—and this they did with the result that the sales of *midget radio sets* soared to great heights. This gain was further consolidated when manufacturers brought out glass counterparts of the small metal tubes. Another step forward in the small-space tube design was the advent of the Bantam tube introduced by Hytron, a design which affixed the letter T to tube types (2).

However the grid cap on both metal and glass types continued to be a thorn in the side of small-space equipment designers until Sylvania introduced the cap-free, type 1231 tube (3). This was immediately followed by a series of RCA tubes having single-ended or capless construction (4). This design was represented by the letter S in tube designations.

Both Sylvania and RCA tubes introduced smaller basings. About the same time Raytheon and Arcturus brought out a series of straight-sided 1.4-V. drycell tubes which in this class represented a reduction in space as well as having other advantages.

However all these attempts to produce a small tube of American manufacture (an English "peanut" tube, in several different types for A.F. use only, having been available to experimenters for several years (5))—except for the Western Electric general-purpose type 215A or "N" tube, of "peanut" size, which drew 250 ma. at 1.1V. and which was never available except as a triode—faded into insignificance when Hytron introduced the finger-size "Bantam, Jr." battery-type tubes (4), which immediately found favor among manufacturers of hearing-aids. It must be remembered however

that meanwhile RCA had brought out a series of extremely small, albeit somewhat costly, type 956 "Acorn" ultra-S.W. battery-type tubes about the shape of an acorn and the size of a walnut (6). The Acorn is still unapproached in its class.

Except for the introduction of new types in these general classes of tubes there was little further observable development towards the production of highly-efficient small-space tubes until RCA last month introduced the MINIATURES.

TUBES FOR "SUPER-MIDGET" RADIO SETS!

Whereas preceding types of tiny tubes, except the Acorns, were designed mainly for A.F. amplifiers (hearing-aids, etc.) these new miniature RCA tubes provide a complete complement for the design of compact, portable, lightweight *radio receiving sets*! Of special interest is the fact that they are highly efficient with a "B" supply of only 45 V. The filament of each of these 4 tubes just announced measures only about 2 ins. long x 3/4-in. in dia. There are no restrictions on the positions in which these 4 tubes may be placed; either vertical or horizontal placement will be OK. Pin numbering is according to R.M.A. numbering system.

The high operating efficiency of these new tubes has been aided by a new design which provides compactness without decreasing the size of essential electrode parts; only the plate has been reduced in size.

Compactness has been achieved by replacing the conventional base with a new glass "button 7-pin" base sealed to the glass envelope; and finally, by mounting the electrodes directly on the glass button.

Can you imagine an inverted glass test-tube (therefore now rounded on top, but having a tip), about 2 ins. long and 3/4-in. in dia., which is closed-off on the bottom with a flat glass base 1/16-in. thick? Well, imagine further that 7 pieces of stiff, No. 18 wire, arranged in a nearly-closed circle (see drawing, "Bottom View"), protrude out of this base about 1/4-in. (to serve as electrodes or connection-pins) and you have a fairly accurate impression of what these new tubes look like on the outside. The envelope is clear-glass, only slightly obscured by getter "silvering."

There is no "base" in the previously-accepted sense of the

(Continued on page 494)

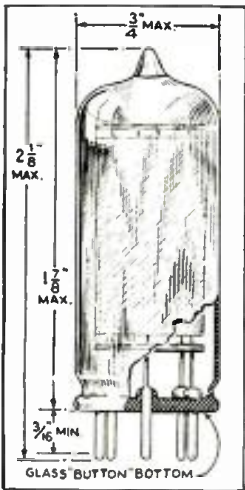

Life-size drawing of tubes. All are the same size.

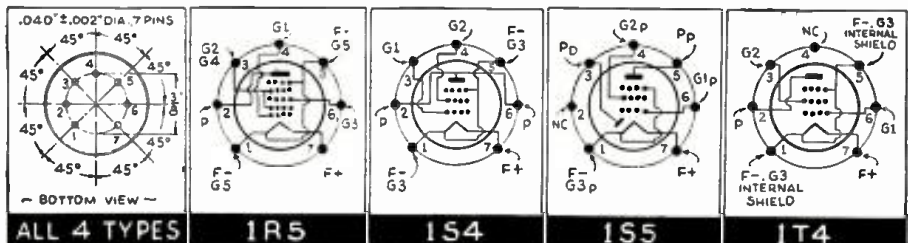

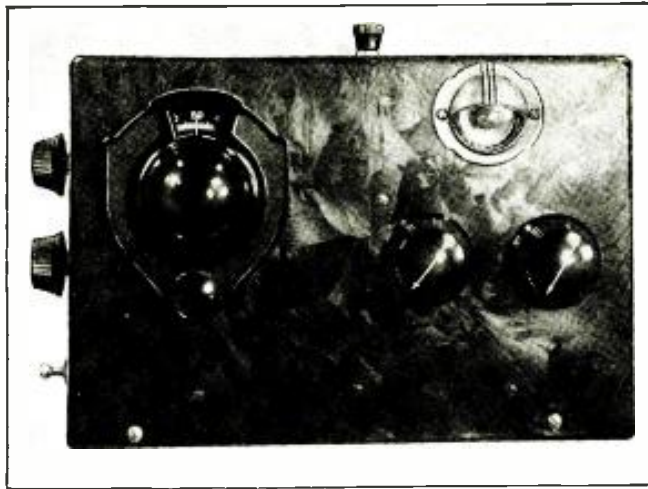

Front view of the ultra-H.F. superhet. Range, 1 meter to 15 meters.

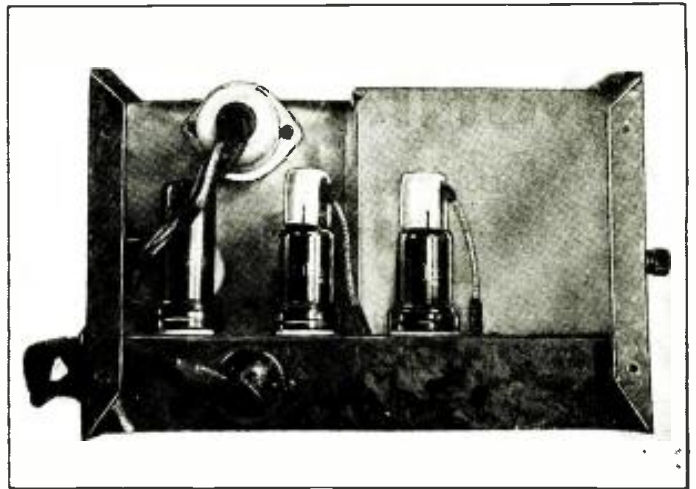

Rear view. Plug-in R.F. coils are used.

BUILD THIS 1- TO 15-METER

An unusual short-wave receiver circuit has been developed, by the owner of to hams. Certain other characteristics and peculiarities of this receiver recommend frequency-modulated program reception. Here is a set, using plug-in

GEO. F. BAPTISTE, W3G8

VERY few ultra-high-frequency receivers have the following features combined: tuning eye indicator, A.V.C., wide band-pass (better than 100 kc. response from 300 megacycles to 20 megacycles), 2-spot tuning above or below the resonant frequency.

A circuit which the writer has designed incorporates these features. It is an autodyne type of superheterodyne, using resistance-coupled I.F., capable of receiving frequency-modulated stations by the use of wide band-pass I.F., and a hi-mu 2nd-detector.

The receiver is small, and can be battery operated. A single-wire antenna or a 2-wire doublet, one side acting as a reflector, may be used to pick up the signal. It has band-spread and employs plug-in coils. It is capable of receiving a limited distance on 28 megacycles by using a quarter-wave doublet cut for 5 meters or 56 megacycles. It also can receive frequency-modulated signals at 50 miles, and has received same at greater distance. Further, the receiver is capable of receiving television sound with excellent fidelity. The receiver is also recommended to Hams who are interested in the ultra-high-frequency bands.

DETAILS

The complete receiver uses 6 tubes as follows: one 954 autodyne 1st-detector, two 6K7 metal tubes or 6SK7 single-ended pentodes as resistance-coupled I.F. amplifiers, one 6F6 hi-mu 2nd-detector, one 6G5 tuning indicator, and one 6F6 pentode A.F. amplifier. If one desires, crystal headphones may be connected to a volume control and condenser, across the voice coil of the output transformer, as shown in dotted lines. Or, a 2nd stage of A.F. amplification may be added, if desired, for increased loudspeaker volume. The quality of the audio response is excellent. The complete receiver is housed in a cabinet 10 x 6 x 6 ins. deep. The receiver power supply may be a separate unit, capable of supplying 135 to 190 volts. It must be well filtered to avoid all possible traces of hum.

The main tuning condenser is an HF-35, mounted on the side of the cabinet alongside the antenna trimmer condenser; the band-spread condenser is an HF 15X dual space type, cut down to 5 plates.

Coil No. 1 consists of 8 turns of No. 12 tinned copper wire wound on a 3/4-in. dia. form, tapped at the 2nd or 3rd turn from the end. This coil covers 26 to 45 megacycles in one complete tuning of the 35 mmf. condenser. The balance of

the coils are all the same diameter, each one being 1 turn less, right down to 2 turns using the same-size wire, being tapped at 1 or 2 turns for the best oscillation results. A clip is provided so that on the extremely high frequencies the 35 mmf. unit is not used. To get the lower frequencies all that is necessary is to use 10 or 12 turns of No. 14 tinned copper wire of the same diameter. All leads must be kept as short and direct as possible, and separated (especially, the grid and plate leads). If 6K7's are used be sure to shield the grid leads with a braided shield and use a metal shield-cap on metal tubes (if 6SK7's are used this will not be necessary). The coils may be opened or squeezed together slightly to adjust the tuning range; this adjustment is not critical. Phone-tips may be slipped over the start and finish ends of the coils, and soldered on, so that the coils may be plugged-in easily; stand-off insulators are used to take these tips.

OPERATION

When placing the receiver in operation turn the regeneration control all the way off and the audio control three-quarters or full-on, then advance the regeneration control until a slight hiss is heard. If the regeneration control is advanced too far the tuning eye will close completely, indicating over-oscillation, and should be kept just below this point. Now rotate the main condenser until a station is heard, always leaving the band-spread condenser set midway or at one-half the dial reading. Finally, by adjusting the antenna condenser and the regeneration control the station can be brought in to the maximum volume. At exact resonance to a strong station carrier the eye will close. In regard to tuning-in frequency-modulated transmitters, the tuning is more critical due to the wide band-pass of the station itself. Another point to remember is that if you are located over 50 miles from such a transmitter don't expect good results; possibly no results will be obtained, although, one of these stations has been heard 200 miles away. Do not be surprised if upon tuning-in a frequency-modulated station that it is not up to standard; a little tuning practice is required, and then again, you may be beyond the coverage distance.

ANTENNA

Note that the antenna should be cut to the correct length, and that it should be at right-angles to the xmitter. Excellent results were obtained from a quarter-wave doublet cut

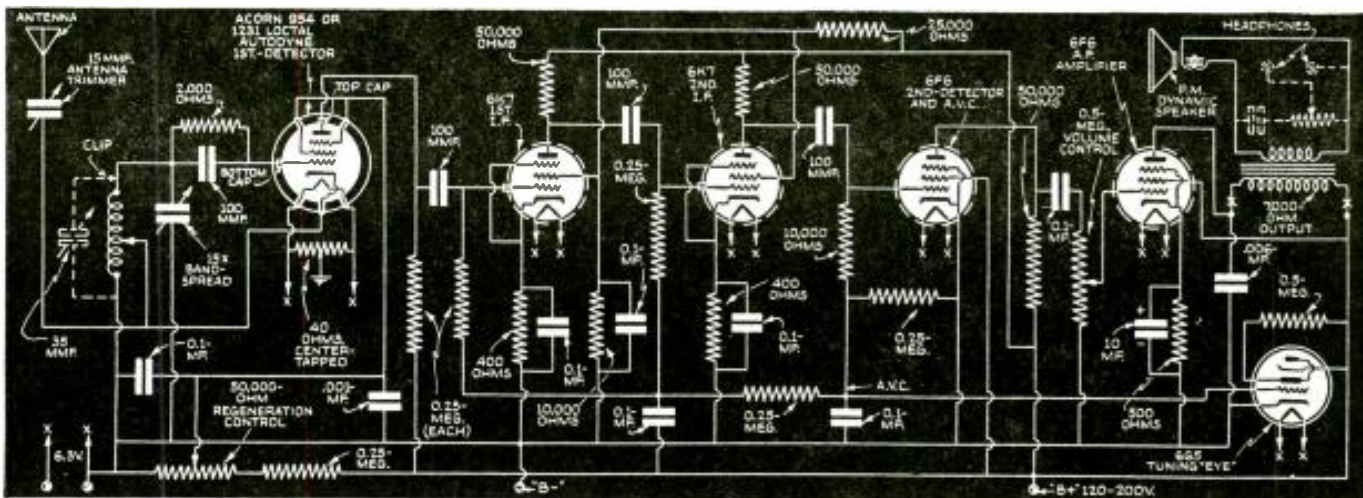

Diagram of the autodyne "superhet." The I.F. is the difference between the incoming signal and the beat-frequency generated in the regenerative or 1st-detector, states Mr. Baptiste.

6-TUBE SUPERHET. RADIO

amateur radio station W3G8, which it is believed will be of exceptional interest mend it to the experimenter who wishes to investigate ultra-shortwave telly sound coils to secure wide wavelength coverage, which should cost little to build.

for 5 meters, each section being 4 feet, 6 inches long, and the lead-in being a regular doublet transmission wire. Only 1 section of the lead-in was used, the other section acting as a reflector; one end of the section acting as a reflector may be grounded to the receiver chassis.

One side of the doublet will work better than the other. This can be checked by tuning-in a station on one lead, and then the other, and noting the closing of the tuning eye. The lead that closes the indicator the most is the one receiving the signal strongest. As a final note, the 954 acorn tube and plug-in coil are housed in with an aluminum shield to cut down interference. This shield is easily made from an aluminum panel. The 954 tube is to be mounted upside-down, through the chassis, so as to reduce the length of the plate and grid leads. This construction will enable the grid lead and the grid condenser to be brought directly to the tuning condenser and tube.

LIST OF PARTS

CONDENSERS

- One Hammarlund, dual-spaced, type HF15X;
- One Hammarlund, type HF15;
- One Hammarlund, type HF35;
- Four mica, 100 mmf.;
- One mica, 0.001-mf.;
- One mica, 0.006-mf.;
- Seven Aerovox paper tubular, 0.1-mf., 600 V.;
- One Aerovox electrolytic, 10 mf., 25 V.;

RESISTORS

- Five Aerovox, 1/4-meg., 1/2-W.;
- Three Aerovox, 50,000 ohms, 1/2-W.;
- Two Aerovox, 400 ohms, 1/2-W.;
- One Aerovox, 10,000 ohms, 1/2-W.;
- One Aerovox, 10,000 ohms, 1/2-W.;
- One Aerovox, 2 megs., 1 W.;
- One Aerovox, 500 ohms, 1 W.;
- One Aerovox, 25,000 ohms, 1 W.;
- One center-tapped, 40 ohms;
- One C.R.L. potentiometer, 50,000 ohms (Vol. Control);
- One C.R.L. potentiometer, 0.5-meg. (Regen. Control);

MISCELLANEOUS

- One Hammarlund acorn tube socket, type S-900;

- Four National octal sockets, C.I.R. series;
- One RCA type 954 acorn tube;
- Two RCA type 6K7 or 6SK7 metal tubes;
- Two RCA type 6F6 metal tubes;
- One RCA type 6G5 tuning indicator;
- One I.R.C. tuning indicator assembly;
- One 6-in. P.M. dynamic speaker (with output transformer, 7,000 ohms plate load to V.C. impedance);
- Nuts, bolts, washers, chassis cabinet, dial, knobs, etc.

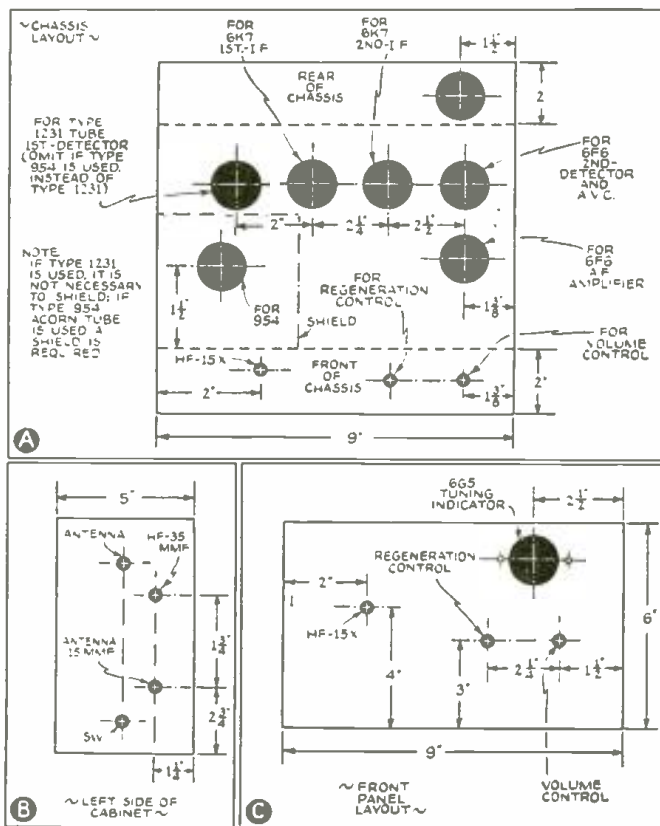

A—subchassis layout; B—left-side of cabinet; C—detail of front panel.

SOUND ENGINEERING

Free Design and Advisory Service
For Radio-Craft Subscribers

Conducted by A. C. SHANEY



This department is being conducted for the benefit of RADIO-CRAFT subscribers. All design, engineering, or theoretical questions relative to P.A. installations, sound equipment, audio amplifier design, etc., will be answered in this section. (Note: when questions refer to circuit diagrams published in past issues of technical literature, the original, or a copy of the circuit should be supplied in order to facilitate reply.)

No. 2

HAND - CAPACITY - OPERATED VOLUME CONTROL

The Question . . .

I would like to convert an expander so as to have it operate as a capacity-operated volume control. I wish to use an antenna using the hand as a control and have the volume increase as the hand is brought nearer the antenna.

I would appreciate it very much if you can help me.

GORDON W. RICHMOND, M.D.
Oakland, Cal.

The Answer . . .

There are a great many ways in which this can be accomplished; Fig. 1 gives a simple capacity-operated volume control circuit. This circuit can be applied to practically any type of expander, so as to obtain volume control action by varying the effective capacity of the antenna to ground.

The circuit consists essentially of a positive feedback oscillator, the feedback voltage being varied by a change of ratio between C1 (which is body capacity) and C2. As C1 is varied, feedback is gradually varied from a negative value through 0 to a maximum positive value. This variation changes the intensity of oscillation from 0 to a maximum value. When the circuit is oscillating, rectification takes place from the cathode to the diodes in such a manner as to pile up a negative voltage across condenser C4. This negative voltage will be equal to the negative peak oscillator voltage present between cathode and ground.

Potentiometer R2 picks off a portion of this negative control voltage and applies it back to the low end of the grid- or (control-grid) return resistors of a super-control (variable-mu 6SK7) or pentagrid mixer amplifier (6L7). When this circuit is being applied to standard expander amplifiers, this control voltage should be substituted in place of the voltage developed by the diode rectifier of conventional expander circuits.

Specific values are not given for each of the components, because a great number of variable factors will affect the ultimate design of the capacity-operated volume control. Some of these factors are:

- Degree of control desired.
- Initial gain of amplifier.

- Type of antenna employed.
- Type of control tube employed.
- Power output of amplifier.
- Maximum body-capacity change.

As the inductance of L1 and shunt capacity C3 will determine the oscillator frequency, these may be selected so as to produce intense R.F. oscillations. Condenser C2 may have a value of 10 to 100 mmf. Item C1 represents the body-capacity of the controller. The remaining values are not critical and may be the following: R1, 0.1- to 5 megs.; R3, 5,000 ohms; C4, 0.1-mf.; C5, 0.05-mf.; R2, 5 megs. Tube V1 may be any duplex diode triode, such as the 85, 6Q7, etc.

PARASITIC OSCILLATIONS

The Question . . .

We have built an amplifier consisting of the following tubes: 1-6J7, 1-6C5 amplifier, 1-6C5 inverter, 4-25L6G's, and a power supply utilizing 3-25Z6's in parallel with 4-40 mf., 300-volt condensers.

We added one 6C5 stage to the original circuit. This amplifier was again modified with different types of phase-inverter circuits, but we seem to lack any power. It is weak and distorted. We wish to use a ribbon microphone.

Can you suggest a circuit that might work to our advantage in using these tubes with some additional parts?

CLARK ROSS,
Hearst Radio Service,
Lead, S. Dakota.

The Answer . . .

Figure 2 shows a circuit diagram of the stable amplifier which will give satisfactory operation. In insert, Fig. 2X, showing the filter circuits, Note*—If filament transformer is used for 1st 2 stages, insert a 42-ohm, 10-watt resistor in series with the 6SC7 and line.

The circuit, as you will note, is composed essentially of a 6SJ7 pentode (or 6J7, which (Continued on page 499)

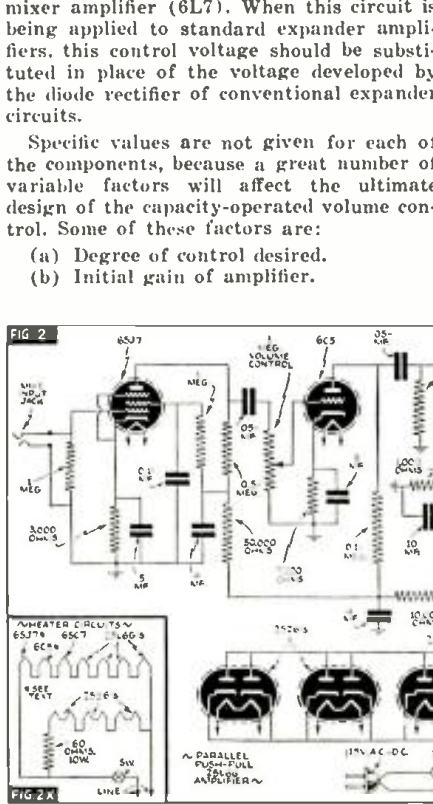
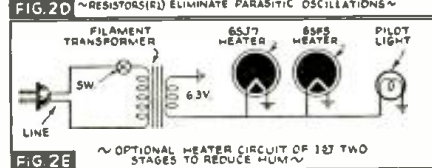
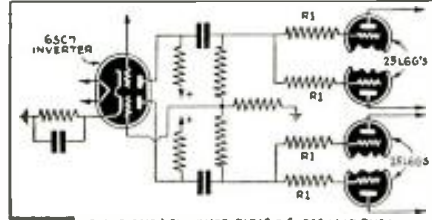
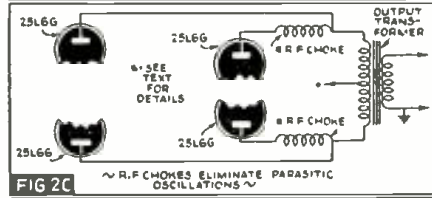
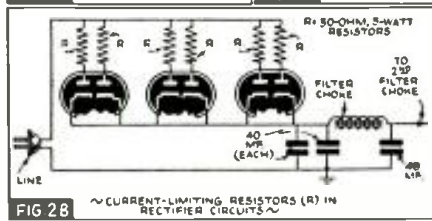
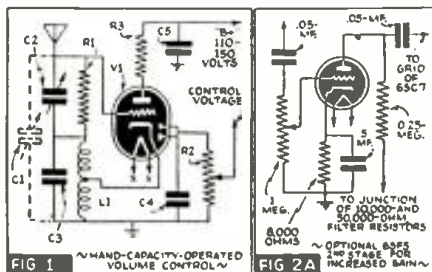

NEWEST ELECTRONIC PIANO

Radio reception and electric phonograph operation too are available, in a special piano-bench the use of which is optional, in the new "Storytone" electronic musical instrument ("Voiced by RCA") here described. Unlike preceding electronic pianos the new instrument utilizes magnetic pick-up from the strings; and a special acoustical system. More business for aggressive radio dealers and Servicemen.

In addition to operating as an electronic piano (employing the general principles described in past issues of *Radio-Craft*—except for certain differences as, for example, the use of magnetic instead of capacitive pickup heads), the new "Storytone" instrument here illustrated and described operates as a radio set, or as a phonograph, if the available special piano-bench (illustrated) is used. This bench contains an RCA Victor radio set and phonograph, in separate sliding drawers, which makes it convenient for the pianist to accompany on the piano any record he may wish to play on the electric phonograph.

TECHNICAL FEATURES

The Storytone piano ("Voiced by RCA") incorporates a 7-tube amplifier with an output of 15.8 watts. The loud-speaker is mounted in an acoustical labyrinth which covers the entire back of the piano. High frequencies are radiated directly from the speaker baffle; low frequencies, from the labyrinth.

As with most electronic pianos a swell-pedal makes an organ characteristic possible. The piano may be played, even by a child, at auditorium volume; or, at barely audible volume as a practice piano! This dynamic range is quite impossible to obtain in non-electronic or mechanical pianos. A special control permits adjusting the instrument to suit individual room acoustics!

The action of the piano is said to be identical with a standard instrument so that the touch to the pianist remains the same.

Since the instrument is susceptible to stray magnetic fields, it should not be placed near other electrical equipment containing power transformers or rotating equipment such as motors or generators. This is particularly true in theatre installations.

The electro-acoustic system consists of 3 major items. First, a magnetic pickup which translates the mechanical vibrations of each string into electrical impulses. Second, a high-fidelity electrical amplifier capable of reproducing the full audio range and having an output of 15.8 watts (2% R.M.A. harmonic distortion). Thirdly, an acoustic transducer system consisting of a ruggedly constructed permanent-magnet dynamic loudspeaker and a folded exponential baffle or horn capable of reproducing with remarkable fidelity and power the tonal qualities required of the fine instrument of which it is a part.

MAGNETIC PICKUPS

In order to translate the mechanical vibrations of the strings into electrical vibrations or impulses so that they may be amplified, individual magnetic pickups are used for each note. These individual units are assembled on 8 separate mounting plates accommodating either 8, 10, or 16 units depending upon their particular location in the instrument.

Each pickup plate assembly consists of a soft steel mounting plate and 8, 10, or 16 magnets with a duplicate number of soft pole pieces. A coil assembly is located over each individual pole piece and they are all connected in series and

*See, for instance, "The DynaTone Phone-Radio-Electronic Piano," *Radio-Craft*, Jan. 1939.

(Continued on page 490)



The "Storytone" electronic piano is an instrument of beauty both in appearance and tone. Mechanical vibrations of its strings are transformed into corresponding electrical vibrations by an ingenious system of magnetic coil pickups.



This is the piano-bench of the "Storytone". The modern radio set in one sliding drawer, and the electric phonograph in the other, are optional.

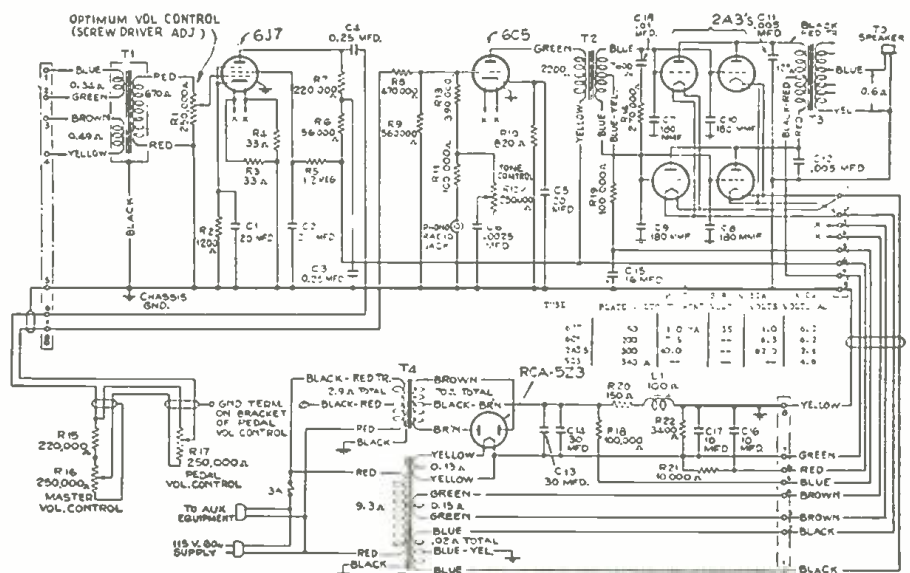
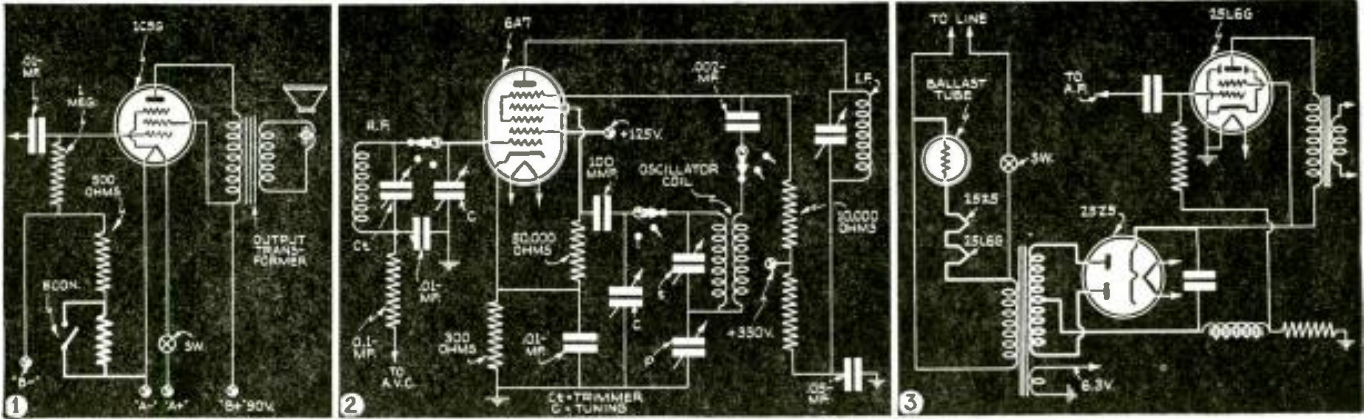

Fig. 1. Servicing diagram of the special RCA high-fidelity amplifier which outputs 20 watts.



NEW CIRCUITS IN MODERN RADIO RECEIVERS



The details of the modern radio receiver circuits that make them "different" from previous designs are illustrated and described each month by a well-known technician.

F. L. SPRAYBERRY NUMBER 29

(1) "ECONOMIZER" USED IN BATTERY RECEIVERS

Howard Models 4B and 4BT—Fig. 1. A method for greatly reducing the B battery drain when normal low volume reception is desired.

The "Economizer" is simply a switch across one resistor in the "B"-negative—ground circuit, which when closed permits all of the "B" battery current to flow through 500 ohms and when open forces it to flow through an additional 1,000 ohms. The 500-ohm resistance in carrying approximately 15 ma. produces a drop of 7.5 volts. This is impressed on the 1C5G control-grid as a bias. It permits maximum power output of the tube.

This maximum power output is by no means desired under all receiving conditions. By increasing the bias of this output tube, which draws about 75% of the total "B" battery current, it is possible to reduce it to about 1/3 or from roughly 9 ma. to 3 ma. For low or normal volume use of the set the grid of the 1C5G is not loaded enough to cause distortion in excess of that occur-

ring at normal bias and maximum output power. By this simple connection the "B" battery drain is reduced to 40% or below!

(2) NEW APPLICATION OF 6A7 TUBE

The Magnovox Co., Inc. Model CR-101M—Fig. 2. Exchange of signal and oscillator sections of the 6A7 tube in this receiver produces desirable results.

The grid adjacent to the cathode, ordinarily known as the oscillator grid is used in this circuit as the signal input grid. From the viewpoint of the signal alone, this provides immediately two advantages: (1) the input capacitance is reduced from 8.5 to 7 mmf.; and, (2) the transconductance is raised approximately 2.5 times by this connection.

In addition to this, A.V.C. action is more effective per volt and as a consequence of less screen-grid current loss both the plate and screen-grid voltages may be somewhat higher than the maximum recommended for ordinary use. The lower transconductance of the signal grid when used as the oscillator grid is no handicap as this may be compen-

sated by more anode-to-grid feedback to maintain oscillation.

(3) THE 25Z5 AS A FULL-WAVE RECTIFIER

Mission-Bell Models 3869 and 3891—Fig. 3. Advantages of full-wave rectification using the 25Z5 and of the exceptionally high mutual conductance of the 25L6G tubes are gained in these designs.

A power transformer of course is required which has a high-voltage winding of the regular center-tap type for full-wave rectification. The two 25-volt filaments are in series across the primary with a ballast tube while the other filaments are supplied from a winding. The circuit permits the use of a 25L6G output tube operating from a supply of much less hum and much better regulation than that afforded by the usual half-wave circuit. In addition to this the filtered output may be 110 to 115 volts rather than the usual 85 or 90 volts due to loss in the rectifier and filter. This circuit of course is not designed for D.C. but makes a better use of the material for A.C. operation.

(Continued on page 491)

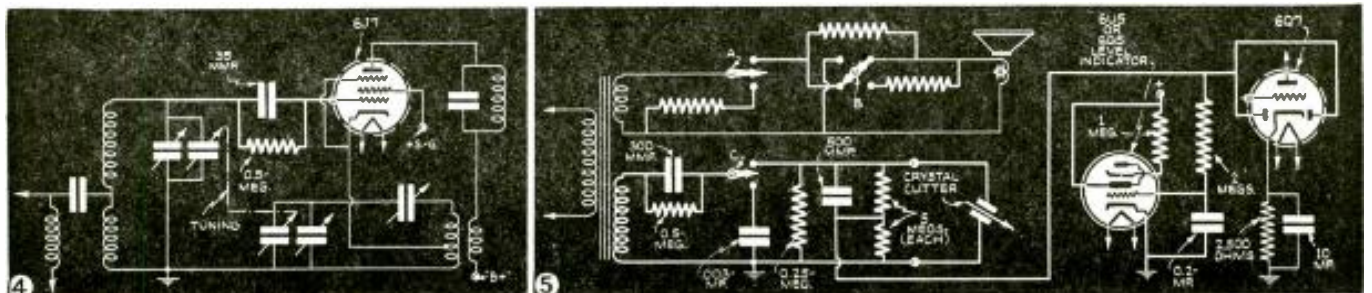

SERVICING PUZZLERS

Solved by the Use of Test Equipment

No. 2

● **Fading Accompanied by Distortion.** This standard set would operate normally for 20 minutes, then fade to low volume, accompanied by distortion. After routine tube and voltage tests were made, the set was connected to the bench. Soon it faded to about one-third volume. Connecting the vacuum-tube voltmeter (or V.-T. VM.) to indicate D.C. values, by using a high resistance in series with the grid, and a bypass condenser to cathode, it was discovered that the A.V.C. voltage had decreased to about zero, and as the set heated further, it became slightly positive. This condition was also checked by means of a milliammeter in the plate supply of the controlled tube, showing a high value of plate current. All bypass condensers in the A.V.C. circuit were checked on a bridge for leakage, and found OK.

Finally the I.F. transformers were checked with a high-range ohmmeter, and a leakage was discovered between the primary and secondary windings of the 1st I.F. coil, while the coil was hot. Upon examination, it was found that one of the silk-covered secondary leads was pulled tight against the plate coil, causing a leakage as the winding expanded. Moving the wire cured the trouble.

H. E. WALLACE

● **Frequency Shift on Broadcast Band.** Trouble in the oscillator circuit of a Philco Model 116X showed up in no reception on short waves and frequency shift on broadcast band, both while set was playing; or having station come in at different point on dial from previous time of play. Usually high-resistance joints prevent oscillation or cause frequency shift. Sometimes rivets holding stator sections of condenser gang loosen, allowing spacing to change and thus cause a frequency change.

We installed a new padder condenser, all new resistors in the oscillator circuit, new grid condenser, soldered all joints on coil. Still had trouble, so just about ready for new condenser gang. Our ohmmeter reads to $7\frac{1}{2}$ megohms with a $22\frac{1}{2}$ -volt battery. As a last resort, we hooked up a power pack and extended the range to 75 megohms. A definite high-resistance short showed up in the grid circuit. Trouble was traced to condenser gang and found to be a small deposit of soldering flux from stator to frame of condenser. Careful scraping with knife, and cleaning with carbon tetrachloride and toothbrush, took care of the trouble.

The short was on the order of 10 to 15 megohms, but varied, getting to quite a low value as the set warmed up, and raising to a high value when cool. Effect was more pronounced, of course, on short waves.

GEORGE D. DAY

In the recent Weston Contest, in celebration of the 50th anniversary of Weston Electrical Instrument Corporation, on "How Modern Test Equipment Helped Me Solve a Difficult Servicing Problem," many letters were submitted which have general interest as typical of today's servicing requirements. A second group of letters is presented here in the form of servicing notes which may prove of value in enabling the Serviceman to obtain the greatest possible usefulness from his test equipment.

● **Interference from Private Power Plant.** After installation of 2 radio sets in urban home, separate interferences were found from 2 sources: (1) spark-plug impulses from a 4-cylinder engine; and, (2) a high-pitched whine from a power plant. Conventional suppressors cleared the sparkplug noise, but no amount or kind of filter touched the whine. The tone controls on the sets could be padded down to about 3,000 cycles before a reduction began to show.

Applying the audio oscillator to the detector of a set, I beat to resonance at 3,600 cycles. This indicated trouble in the generator, so I plugged the cathode-ray oscilloscope to the 115-V. city lines (controlled 60 cycles), applied this internally to the horizontal sweep, applied the private lines to the vertical and adjusted these (at the generator) in step at 60 cycles. Then placing the cathode-ray instrument on the private lines I got a modulated 60-cycle sine curve. This was traced on a piece of tissue paper for analysis.

The nodes in this curve indicated an extraneous voltage of 15 to 20 volts at a frequency of 3,600 cycles. I now "zeroed" the V.-T. VM. on 115 volts r.m.s. city lines and measured the private lines, and found 18.5 volts still present.

Diagnosis was as follows: Generator, 4-wire, 3-phase, 4-pole, 6 coils to the pole, 72 slots in the stator - rotor field. Trouble—one pole had been connected "5 coils" and the next "7 coils." Correction—open windings and check the resistance of each pole, locating improper connection and reconnecting so all poles had same resistance.

P. L. STAFF WILLSON

● **Trouble in A.V.C. Circuit.** In an Atwater-Kent Model 85 receiver, point-to-point voltage tests with a 1,000 ohms/volt meter showed circuits normal. When a 20,000 ohms/volt meter was applied, the bias voltage on the 1st-detector and 1st I.F. tube showed ab-

normally high, and indicated trouble in the A.V.C. circuit.

Upon checking the control plate resistor with the ohmmeter, it proved to be open and was causing the trouble. This resistor has a value of 800,000 ohms (0.8-meg.) and therefore requires a high-range ohmmeter to check it accurately.

L. S. WARD

● **No Signal on "Shortwave Broadcast" Band.** The regular broadcast band of a Stromberg-Carlson Model 240M was perfect, but there was no signal on the shortwave broadcast band.

A Weston Model 669 V.-T. VM. was connected across the oscillator circuit with the set on the broadcast band and the oscillator voltage was within 70 per cent across the dial. We then changed the band-switch to shortwave and our V.-T. VM. went down to zero. When turned back to broadcast, the oscillator started again, the voltage registering on the meter. We turned it back to shortwave and again there was a zero voltage. A new 6C5 oscillator tube put this set back in shape. By having a high-grade V.-T. VM. which could be shunted across the oscillator circuit tuning condenser, we were able to localize this trouble in about 5 minutes and correct it without using a soldering iron.

RICHARD J. DOYLE

● **Distortion After Perfect Playing.** This trouble was found in a Zenith Model 103, which is a 14-tube super., using 4 type 35 tubes in 2 stages of R.F. and 2 stages of I.F. A type 24 mixer and a type 24 A.V.C., the other tubes being 27's and 45's in the output stage. All tubes tested OK.

In the shop, I discovered that the A.V.C. voltage at the control-grid dropped off when the set warmed up, and the reproduction became distorted. Thinking there was something wrong with the A.V.C. circuit, I checked the values of all the resistors and checked all the condensers for capacity and leakage. After lining up the I.F. trimmers and gang trimmers and checking the audio for distortion, I started in substituting one tube after another with no better results.

Finally, I hooked up my Weston Model 72 in series in the control-grids of each of the screen-grid tubes and found that the control-grid circuits of 3 of the type 35 tubes were drawing current, indicating gassy tubes. I replaced these tubes, and the set was OK. Although I had replaced each of these tubes with a new one, there were always 2 that were bad, left in the set, thus offsetting the A.V.C. voltage and causing the distortion!

FRED H. WEIN

(Continued on page 495)

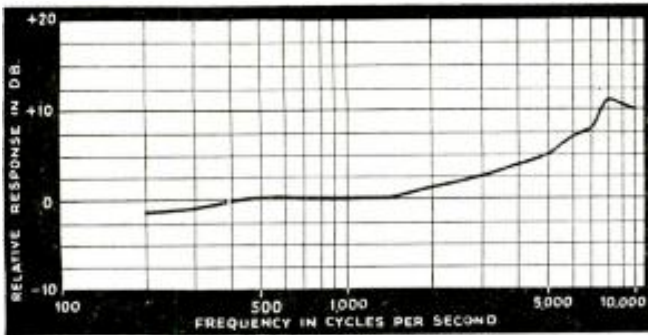

Fig. 1. Graph showing the frequency composition of surface noise from a test record.

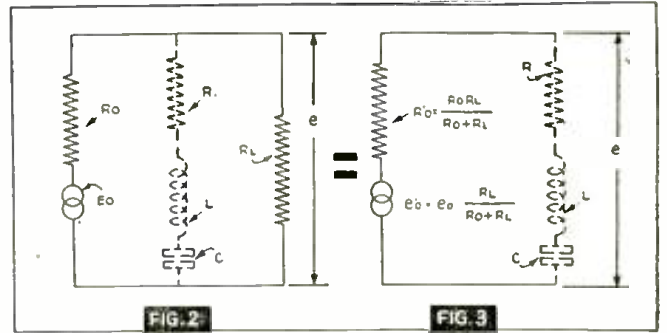

Figure 2 shows the added elements shunted across the circuit between source resistance and load resistance. Figure 3 shows same circuit simplified. See text.

SCRATCH FILTER DESIGN

Needle scratch, or "surface noise" as it is called, in the electrical reproduction of phono records, is a problem which is familiar to every owner of electrical phonographs, and phono-radio sets. "Scratch Filter Design" in discussing this problem analyzes the factors which make scratch apparent; and gives procedure for designing corrective networks.

By H. S. MANNEY

IN the correct meaning of the term there can be no true "scratch filter"—in connection with the electrical reproduction of phono records—for such a device must remove the undesired components and leave the desired sound unimpaired; and, in the present state of the art, spurious signals within the required audio range, once admitted to the sound channel, cannot be removed without loss of fidelity. The practical problem for the designer of reproducing equipment resolves into one of affecting the happy compromise of developing sound from the speaker of the best quality of which the record is capable.

WHAT CONSTITUTES "SCRATCH"?

"Surface noise" or "needle scratch" results from the reaction of the needle to minute irregularities in the record. These are of the nature of grain of the material, irregularities in the action of the cutting stylus of the recorder, and abrasive added to the record material for the purpose of grinding the pickup needle to fit the groove.

"A 5,000-cycle note of the same loudness as a 10,000-cycle band of surface noise using a reproducer with a flat characteristic would have an amplitude of only about 0.000,001-inch."

The random distribution of magnitudes and separations of the resulting disturbance produces noise having components of all frequencies which the pickup is capable of converting into electrical signals. The noise components in the upper portion of the audio spectrum are definitely more pronounced and, everything else being equal, the more extensive the upper range of the pickup, the more troublesome will become the noise-to-signal ratio from a given record. The energy distribution of the noise from a particular record is shown in Fig. 1. The pickup, like all mechanico-electrical transducers, is predisposed to

several resonances. Only by most careful design and proper damping (with its attendant sacrifice of sensitivity) are these resonances kept under reasonable control.

FILTER FUNCTIONS

The peaks found in many or most pickups are likely to be in the upper part of the spectrum and hence accentuate surface noise between, say, 2,500 and 6,000 cycles. One desirable function of a well-devised "scratch filter," then, is to attenuate the most troublesome peak or peaks. Resonances of the type which produce valleys in the response curve are not usually serious, unless they are wide enough to depress a substantial part of the spectrum; and, as a rule, corrective measures directed toward elimination of valleys impair quality more than they improve it. Quite apart from its effect on noise, insofar as a filter removes a sharp peak, it is safe to assume that it improves the overall frequency response (as the ear judges the result).

The upper end of the spectrum contains in addition to the major portion of the noise, spurious harmonics of lower frequencies and cross-modulation products. The latter may easily be offensive enough to argue for high end suppression even in the absence of surface noise. It is well known that the amplitudes of the original sound in the range below about 2,500 cycles are much greater than at the higher frequencies. It follows that these higher frequency components react on the ear at lower loudness levels. The subjective effect of reducing the physical amplitude of such components is therefore less than proportional to the physical reduction due to the characteristic of the ear. This consideration and the reduction in the amplitude of cross-modulation products emphasize that the degradation in quality may not be as great as expected when the high end is drooped for purposes of suppressing surface noise.

IDEAL FILTER

The ideal noise filter for a given combination of record, reproducer, needle, amplifier and speaker, may be defined as that which produces the necessary noise suppression with the least sacrifice of desired high-frequency sound components. One way to accomplish this end is to attack the offending resonant peak, if the pickup has one, and then droop the upper end of the characteristic in an optimum manner. The latter result is best accomplished through an adjustable device with the ear as judge of results, since the surface noise will vary with the condition of the record played.

It is suggested, therefore, that the so-called scratch filter consist of 2 parts: (1) a resonant circuit which produces a valley the inverse of the reproducer peak, to be designed with fixed elements and built into the reproducing equipment; and, (2) an adjustable control which may be varied according to the taste of the user, the record, and the needle used. The remainder of this article will describe the design of a resonant arm consisting of resistance, capacity, and inductance placed across the circuit and an adjustable resistance-capacity arm also placed across the circuit.

"RUNNING A CURVE"

The resonant circuit has a specific function; that of counteracting the resonance of the type of pickup used. It is therefore necessary, before design can be considered, to determine the shape and location of the resonance curve of the pickup. If a dependable response curve can be obtained from the manufacturer, the problem is simplified. If not, a curve can be run using a multi-frequency record and a flat amplifier system, provided the record calibration is available. In the absence of the record calibration, it is possible to calibrate the reproducer directly.

Direct calibration of a pickup is the

(1) Frederick, H. A.: "Vertical Sound Records," Trans., Soc. Motion Picture Engineers, Vol. 18 (1932).

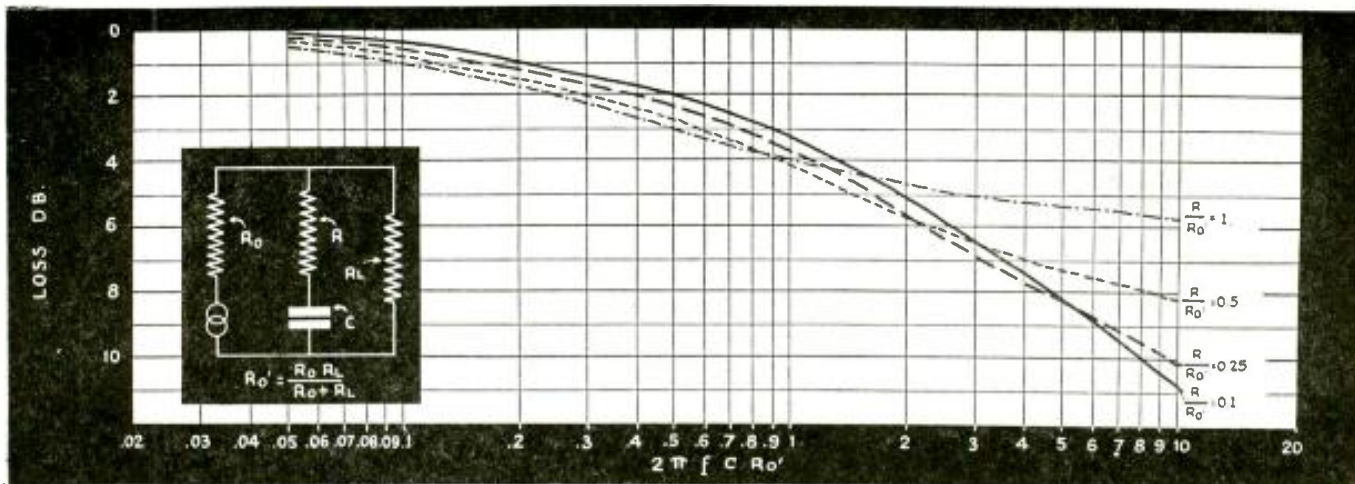

Fig. 4. Insertion response curves obtained by varying only R as explained in the text.

least convenient method of determining its response curve, but it is the most reliable. Methods of doing this are (1) to force-drive the stylus by a driving mechanism having known and controllable amplitudes and rates of vibration; (2) optically calibrating a record and then calibrating the pickup from it; and, (3) calibrating the pickup by the inverse speed method using any suitable multi-frequency record.

The latter method is the only one available to the average laboratory and it is believed by the writer to give the greatest accuracy. In this method, the record is driven at various speeds, the record is driven at various speeds from the same frequency section of the record to reproduce various electrical frequencies. It is perfectly obvious, of course, that the electrical frequency reproduced will be directly proportional to the rotary speed of the record. At first thought, it may seem that the entire spectrum may be calibrated from a single record frequency if the speed is varied over a wide enough range. However, such speed ranges are difficult to obtain, and accuracy is greater and control easier if restricted speed ranges are combined with a considerable number of record frequencies. The latter argument follows from the fact that at least one resonance of importance results from the reaction of pickup and stylus with some property of the record material, presumably grain, and the actual groove velocity is a factor in this reaction.

The turntable bearing the record may be driven from any adjustable speed motor having the correct range of shaft speeds. A practical driver is a spring-motor-driven turntable with an adjustable governor. The driver may be coupled to the driven turntable by means of a rubber band. The combination of an oscilloscope and beat-frequency oscillator is one ready means of evaluating the speed of the record through determining the reproduced frequency. Correction of the final output readings must be made for the relation between speed and amplitude of induced voltage in the pickup. Since amplitude is directly proportional to frequency, the output readings in decibels are corrected by adding corrections figured from the formula:

$$\text{correction} = 20 \log \frac{f_r}{f_s} \text{ db.}$$

where f_r is the frequency recorded and f_s is the electrical frequency as reproduced.

When the response curve of the pickup is obtained, it may be examined for the resonant peak. By drawing an assumed sweeping curve through the characteristic in the region of the peak, the shape of the resonance curve may be fairly well defined. It is this resonance curve inverted, that the required resonant circuit must fit as well as may be practicable.

NETWORK DESIGN

While there are many possible network configurations which will accommodate the required curve more or less exactly, the simple 2-terminal arm shown in Figs. 2 and 3 will be designed here.

A point in the circuit is selected on the basis of convenience, for insertion of the resonant combination. Figure 2 shows the added elements shunted across the circuit between the source resistance and the load resistance. Figure 3 shows the same circuit simplified by combining, for convenience, R_0 and R_L into their equivalent parallel value R_0' . The insertion transmission t , of the added elements, R , L , and C , is the vector length of the ratio of the source and

delivered voltages in Fig. 3:

$$t^2 = \left[\frac{e}{e_0} \right]^2 = \frac{R^2 + (X_L - X_C)^2}{(R + R_0')^2 + (X_L - X_C)^2} \quad (1)$$

X_L and X_C are of equal value at f_r , the frequency of resonance and this value will be called X_r . Therefore,

$$t^2 = \frac{R^2 + X_r^2 \left[\frac{f}{f_r} - \frac{f_r}{f} \right]^2}{(R + R_0')^2 + X_r^2 \left[\frac{f}{f_r} - \frac{f_r}{f} \right]^2} \quad (2)$$

Transmission is minimum at f_r and its value is

$$t_r = \frac{R}{R_0' + R} \quad (3)$$

R_0' in equation (3) is established by the original circuit, and it will be assumed that no changes will be made in the elements determining this quantity. Since t_r is given by the requirements of the resonant equalizer under design, the value of R may be determined at once from (3):

$$R = R_0' \frac{t_r}{1 - t_r} \quad (4)$$

It will be apparent to the reader that t_r is the transmission ratio corresponding to the maximum loss desired. This maximum loss in decibels is given by

(Continued on page 498)

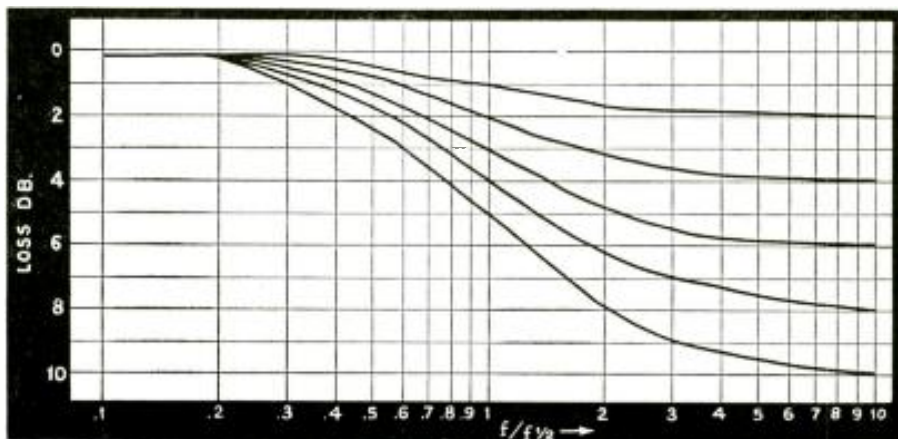

Fig. 5. Curves like those of Fig. 4 but aligned along the frequency axis. These are obtained by varying R and R_0' (in Fig. 4) simultaneously.

SERVICING QUESTIONS & ANSWERS

P.T. BURN-OUTS—HISSING— RESISTOR BURN-OUTS

(143) R. F. Sherfy, Sunbury, Ohio.

(Q.) Will appreciate it if you can help me on some trouble with a Stewart-Warner model R102A: (1) The power transformers seem to burn out frequently. Is there any special cause? (2) Cannot get out a "swishing" or hissing noise when volume control is near full-on. Tried a new one, same trouble. (3) The 2 resistors, 6,000 and 5,000 ohms, respectively, parts Nos. 67,330 and 67,329, over-heat and burn out. I tried 1,200 ohms extra in series but still they get hot.

(A.) (1) The Stewart-Warner model R102A receivers frequently have burned-out power transformers from overload, caused by filter or bypass condenser breakdown. (2) To cure the "swishing" noise, which is tube noise, and common in all high-gain amplifier systems, increase the capacity of the type 24 detector plate bypass condenser from 250 mmf. to any value up to 0.002-mf.; the proper value to use may be found by trial. (3) The bleeder resistors may be increased to 12,000 and 10,000 ohms, respectively, which will give less heating and approximately the same voltages.

FADING

(144) T. Wajeiechowski, Brooklyn, N. Y.

(Q.) I have an RE20 RCA Victor. It plays a few minutes and then it fades. If the set is switched off for a few minutes and then turned on again it plays loud again and fades as before. Sometimes while the set is playing, if I short the cap of the 1st I.F. tube to the chassis with a finger, the set dies away. It comes back if the cap of the 1st-detector is touched. The set will also come back to original volume if a wire from the chassis is hooked to the lead going from the 0.5-meg. resistor to the control-grid of 1st I.F. and R.F. amplifier.

I have tried replacing all condensers, one at a time, have resoldered all coil connections, have replaced the tubes one at a time, aligned the set and it still fades. I also replaced all the resistors at one time. After this the set did not fade much; but now, after playing for a while, if the switch is snapped off and on there is an increase in volume. There is some distortion present also.

(A.) The condition which you experience with the RCA Victor model RE20 is one common to this particular model;

fading is almost always caused by a leaky 0.1-mf. condenser in the power unit. This condenser, one section of a block, and identified by a blue lead, is employed as a grid filter.

Distortion is probably due to a carbonized voltage divider system. It is best to replace these carbon resistors, employing a 5-W. wire-wound unit as the screen-grid drop section.

CRACKLING NOISE

(145) W. R. Wonsettler, Oil City, Pa.

(Q.) I have a Grunow model 11G in my shop for service which is giving me no end of trouble. This set was in another shop 2 months without success. It uses the following tubes: 3-6K7's, 2-6C5's, 2-6F6's, 1-6H6, 1-6G5 eye tube, 1-5Z3, 1-6A8.

An extremely violent crackling noise, and hiss, are evident at all times. Shorting-out the 6A8 completely, stops the hiss, and puts the noise so low it can hardly be heard. Pulling out or shorting the 6K7, has no effect, indicating the trouble should be in the oscillator-mixer.

I replaced the broadcast oscillator coil, with no effect. This noise is on 2 bands and not on the 3rd. The results of a signal-tracing test, using a signal generator, were as follows: antenna post, no signal; primary, antenna coil, no signal; secondary, antenna coil, weak signal; primary, R.F. transformer, weak signal; direct input to 6A8, strong signal and weak station pick-up.

All these coils show good continuity and no leakage between windings on my 1.5-meg. ohmmeter. All plate and screen-grid voltages are normal, about 5 per cent lower than as listed in the tube data book. Plate and screen-grid currents on the 6K7 R.F. tube are about 5 per cent lower than as listed in the tube data book, thus corresponding to the slightly lower plate voltage, and indicating a correct grid bias (which I cannot measure with my instrument).

Plate and screen-grid currents do not follow any of the noise on this 6K7. I connected a meter into the 6A8 oscillator plate circuit and it followed the noise slightly. The plate feeding the 1st I.F. coil has a normal current also and follows the noise a little.

I replaced all bypass (power) condensers, and also all the filter units, with no results.

All resistors show continuity. I disconnected the tuning condensers and tested for shorts but with no luck. I also carefully checked the waveband switch, without disconnecting any leads. All ground connections and most other connections were unsoldered. Could the coils be bad in this set in spite of the way they check? All tubes were replaced so the trouble is not in them. This set is a headache.

(A.) You have trouble either in the A.V.C. circuit or with a lateral-wound primary coil of one of the stages.

For trouble in the A.V.C. circuit, (Continued on page 502)

P. A. SALE TO SKATING RINK

I HAVE found that

in most every Roller-drome (skating rink, to you) the music is of very poor quality and in many cases it cannot even be heard when very many skaters are on the floor. If you are a skater, you will probably agree with me on this point. If you are a rink owner, you will say "I have got the best equipment that money can buy, so how will I eliminate this trouble and get good-quality music?" My answer to you, Mr. Rink Owner, is that this trouble can easily be eliminated, providing you are willing to call in a competent sound man and use only sound equipment that is made by an old-line amplifier manufacturer and not some of the "fly by night" concerns that offer you equipment at ridiculously low prices.

The writer has just finished installing the sound equipment for the Farr Roller-drome

W. L. FULLER, JR.

here in Parkersburg, West Virginia. They

are using the following equipment:

1—Thomas B. Gibbs amplifier, model No. 45XXO, which peaks at 45 watts.

2—small horns with Oxford 12-in. P.M. speakers.

Mr. Farr already owned 2 flat baffles, 4 ft. square, and 1 wooden horn, 4 ft. long, that he had been using at his swimming pool this summer past. In this equipment was also a crystal microphone. Another piece of equipment that the writer had to install was a new electric organ, which now is being used 6 nights per week and is re-amplified through the microphone and sound equipment. Two afternoons a week, for the matinee, an automatic phonograph is used for the music for the skaters.

The rink is located in a building 150 ft. (Continued on page 500)

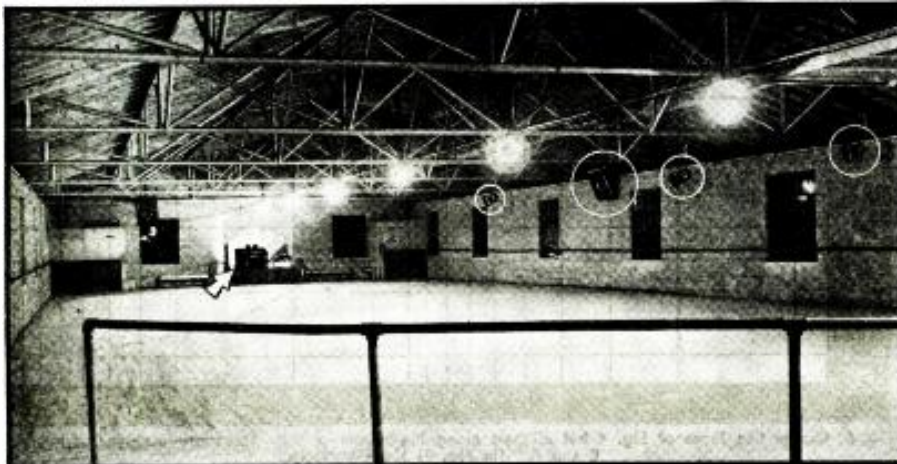

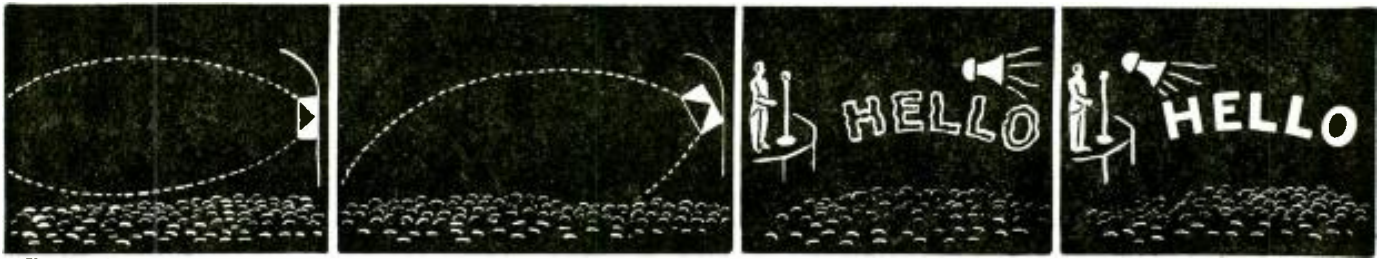

Fig. 2A—Incorrect speaker angle.

B—Correct speaker angle.

C—Incorrect speaker placement.

D—Correct speaker placement.

How to Select and Place **SOUND EQUIPMENT**

Much has been written about sound equipment but nearly always the discussions have been either highly technical or devoted mainly to one or two specific items. It is hoped therefore that the following, brief 4-part article will have value as a coordinated presentation of elementary sound data.

*PART II LOUDSPEAKERS

WITHOUT an enclosure of some kind to act as a sounding board—similar to the sound board on a piano or other musical instrument—any loudspeaker will rattle and produce only thin, high tones instead of natural, full-body tones. Even damage may result to the speaker if it is operated without an enclosure of some sort.

There are 3 styles of speaker enclosures commonly used (see Fig. 1): the *baffle*, the *projector* and the *trumpet*; the baffle, however, as we shall see, in some instances may not seem to be an "enclosure" except perhaps in an acoustical sense.

BAFFLES

The Baffle is the most commonly used type of speaker enclosure. It spreads the sound over the widest possible area, and consequently does not direct the sound as far as Projectors or Trumpets. Its types and uses are:

Walnut-Finish Wall Baffle: For church, mortuary, auditorium, ball room, and similar interiors where a dignified wall baffle is desired.

Flat-Baffle Board: For mounting speaker flush with the wall. May be covered with decorative tapestry to fit the furnishings of any room.

Carrying Case: Used in all types of portable work. Also protects speaker—weather-resistant.

* Part I, last month, described Microphones.

Dynamic Reflex: Emphasizes bass. Especially good for music where the low tones are important, as in church and mortuary organ music.

PROJECTORS

This device directs sound in a narrower beam and causes it to carry farther than do Baffles. Also they produce crisp, penetrating tones; and force sound under balconies, out over athletic fields, etc. Its types and uses are:

Steel Alloy: For outdoor and indoor work. Most sturdy horn we know of. Spun steel-alloy. Built to stand all-around hard service.

Aluminum: Less rugged but a good horn where initial cost is important.

Flared Baffle: Has the mellow tone of the baffle plus the directive qualities of the projector. Use it behind screens or built in the wall.

TRUMPETS

This enclosure confines sound to a comparatively narrow beam, and thus directs it the farthest possible distance. Produces a crisp, more penetrating tone than Projectors. Used extensively for stadiums, belfry chime systems, etc. Its types and uses are:

Seamless Spun: The strongest trumpet built. Seamless spun construction assures years of service without denting or bending. Made of steel-alloy.

Sectional Aluminum: Made of durable

aluminum; comes in 2 sections which bolt together. Gives good results with speakers designed to properly fit it.

Compact Type: Rain can't hurt it. Same steel-alloy construction as seamless trumpet above. Use it anywhere for best results on both music and voice.

GENERAL DATA

Volume controls may be easily connected to each speaker . . . adjust volume to suit individual locations. These are incorporated in the larger sound systems, where church belfry horns and indoor baffles are likely to be used at the same time, so the volume on the indoor speakers can be reduced.

Where projectors and trumpets are permanently mounted out-of-doors, the use of covers assures trouble-free service. They may be easily slipped on or off. Rain proof, compact trumpets need no such protection. Baffles may be used outdoors, but should always be taken in out of the weather after using.

Whenever speakers are operated more than 150 feet from the amplifier, a long-distance transformer must be used on each speaker, or a speaker selector box used, which will accommodate up to 6 speakers. Either the transformer or selector box easily connects to the 500-ohm terminals on the amplifier.

In all installations, the speakers should
(Continued on page 499)

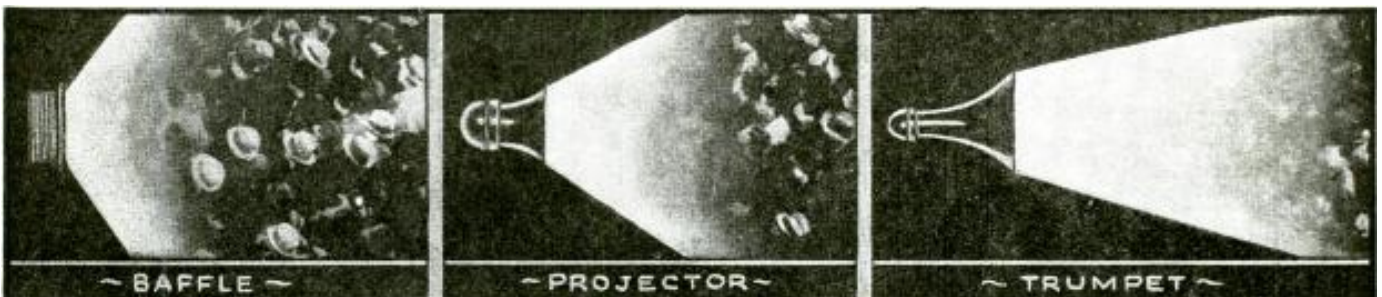
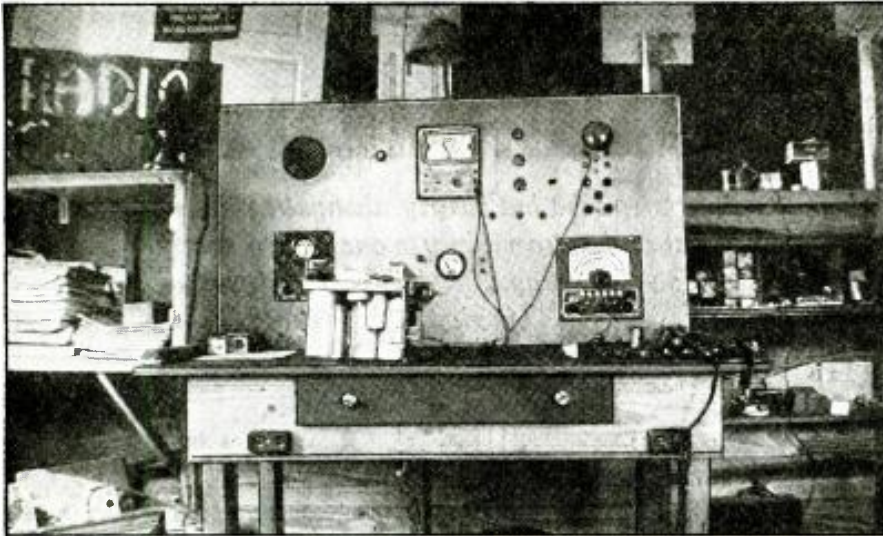

Fig. 1. Angles and depths of audience coverage with various types of baffles and horns.

MY SMALL-TOWN SERVICE SHOP

"I moved into a town of 1,600 people, started a service shop on practically a dime and succeeded despite a long-established competitor."—Mr. Powell's remarks in this article are his own and do not necessarily reflect the opinions of RADIO-CRAFT.

ROY POWELL



This is the self-made moneymaking workbench of Mr. Powell. The instrument board contains several commercial units plus many home-made practical instruments. It is perhaps not the ultimate in professional appearance but it earns a livelihood for him—and that's what counts.

The Article . . .

In the Radio Service business the 2 most difficult and non-profitable problems are the "Intermittent Bug" and the "Test Equipment Bug." Gradually, instruments are now being put on the market that enable the repair man to deal the death blow to those intermittent problems in a much shorter time, thus enabling the repair man to produce a better, more economical job in much shorter time.

These instruments do a jam-up job and are worth their price many times over. But when the repair man has a small town in which to operate, as does the writer, the price of these instruments and the rapidity with which set models change, making his test equipment inadequate, the test equipment problem looms up a "bigger bug" than the intermittent and when you have a combination of the 2, then to say one gets terribly discouraged is putting it entirely too mildly.

The following is a discussion and description of how the writer has to a very great extent overcome the 2 bugs and at the same time made a pretty fair living in a town of 1,600 people with one competitive service shop that had been operating here for several years before we moved in.

The writer might state here that he sticks strictly to service and installation, the sales he comes in contact with being referred to the 2 local dealers for whom he handles service and installation.

FOUNDATION

The writer moved to this town about 18 months back and started in business

with "The War Department" (wife) as an official book-keeper, telephone girl, and head of the tube testing and selling department; a '36-model Plymouth automobile; and, a volt-ohm-milliamperemeter costing \$23.50, and a signal generator at \$15, which he had acquired while working for a furniture store on a salary. A total sum of \$40, in cash, was left after moving down the 2 rooms of furniture. Parts on hand were a few bypass and filter condensers, resistors and 4 audio transformers; tubes were obtained on consignment in a deal supplying 2 manuals. Ten dollars of the 40 went for rent on a small, fenced-off space in a garage, for a shop. Seventeen dollars went for an English-reading tube tester. Last, but very important (as you will later see) \$3 went for a special rate on *Radio-Craft* for 2 years.

The signal generator we retired just as soon as we had adequate credit to purchase another one the parts distributor had used to demonstrate. This we got for \$25 instead of \$36.50 which it sold for, new.

Now we had the foundation for our Radio Service business. And during our spare time we busied ourself with getting the other necessary equipment to enable us to turn out our work faster and take care of the intermittent jobs and all slow-moving work.

EQUIPMENT

In one of our *Radio-Craft* magazines we found the description of a transformer for varying the line voltage from 90 to 145 volts, this we constructed to help the intermittent sets to cut off so that we might slip up onto the trouble. Cost—about 1 hour's time.

The Letter . . .

I am enclosing with this letter an article that I thought might possibly be of some interest to someone other than myself and might if it should get far enough along be of some help to some other struggling Serviceman like myself.

I would be very much honored if you should be able to use it or any part of it. It was not prepared as an advertisement for your magazine but does contain quite a bit of *Radio-Craft* material. If most Servicemen are like myself they read the articles and look at the advertisements but very seldom try any of the circuits on test equipment. I have read *Radio-Craft* regularly since 1932 but always bought my equipment ready-made. But recently financial difficulties have prevented my buying much equipment I needed so I have found a new use for *Radio-Craft* and a most profitable one.

I wonder if other Servicemen in circumstances similar to my own could not profit by this "autobiography" of my service shop. I realize this article is a little long to hope for a place in your magazine but it is just as short as I could make it and get in one-third I would like to say.

Thanking you kindly for your time, I am

Yours truly,

ROY POWELL

Next we needed an oscilloscope, not so much that we needed it for realignment but our competitor had one and advertised the old X-ray soap. Well we found in a back issue of *Radio-Craft* (we save them all) an article on how to build one using a 913 tube for about \$10; this we built, using instead a 2-in. tube. Now we X-ray too. Cost—about \$12.50.

We found that we very much needed a meter that could be used to check A.V.C. and grid voltages without disturbing the operation of the set. Our parts man brought us out one of the 20,000 ohms/volt type but we found as all other Servicemen have, I imagine, that this would not do the job satisfactorily and the meter was so delicate it was out of order before the salesman was well out of town. When he came back in 3 weeks we met him at the door with it—and 20,000 words not so kind to hear. We decided that nothing but a V.-T. voltmeter would do, so back we went to the magazine file, and after glancing through several issues we found just what we wanted, one that was simple to construct and where most of the parts could be found in the junkbox. With an old Weston 301, 0-1 meter we had on hand, and about 2 hours' time, we had a very efficient vacuum-tube voltmeter. Cost—about \$1.

By this time the channel analyzers had hit the market but we could not see where we could invest roughly \$100 for any one instrument even if a Serviceman's prestige was enhanced by being furnished with it. So again our spare time was taken up in the magazines and after trying several different types of

(Continued on page 497)

USEFUL KINKS AND CIRCUITS

Contributions to this new department are paid-for at space rates; what previously-unpublished ideas to help fellow Servicemen, experimenters, etc., do you want to submit? A short description and pencil sketch will do.

"BLACK LIGHT" FILTER

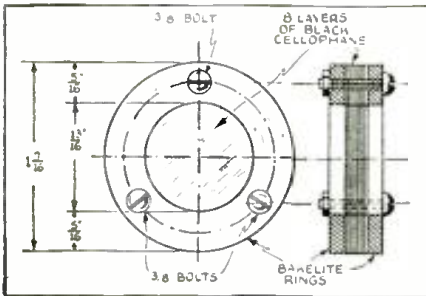

● A SIMPLE filter that is ideal for photoelectric-cell work can be made very simply and inexpensively. The drawing shown here gives all dimensions and structure. This particular filter was designed for use with a 21 candlepower auto lamp, but if you are using a stronger light just add more layers of cellophane. I have had great success with this type filter as used for "electric eye" burglar alarms, invisible-light wild animal photography, light transmission, etc.

MARTIN D. KOEHLER,
Elmwood Park, Ill.

"INTERMITTENT" INDICATOR

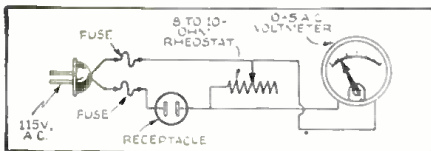

● THIS instrument was primarily designed to register any changes in watts consumption of intermittent receivers, but the rheostat may be calibrated to make a wattmeter.

The meter was rescued from the junk heap out of an old "B"-eliminator.

The set under observation should be plugged into the receptacle and the rheostat adjusted until the meter reads on the center position.

W.M. ORRETT,
Orrett's Radio Service,
Toronto, Ont., Can.

XTAL PICKUP COMPENSATOR

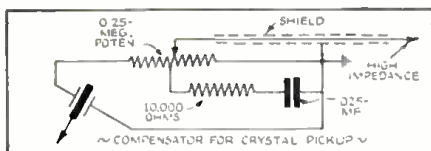

● SHOWN here is a suggested compensation for a crystal pickup when used with public address systems of medium or high power. Isolate the compensation circuit by shielding.

RCA MFG. Co.,
Commercial Sound Div.

NEEDLE SCRATCH FILTER

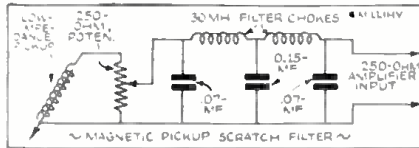

● A NEEDLE scratch filter for magnetic pickups when used with public address systems is shown. The scratch filter assembly should be isolated by shielding.

RCA MFG. Co.,
Commercial Sound Div.

EMERGENCY RECTIFIER

● ONE day as I turned on the power pack the rectifier tube, which was an 80 tube, burned out. The radio store did not have any in stock so I tried this stunt. Another radio set of mine had several type 71 tubes. I took two of them and connected them in the following manner:

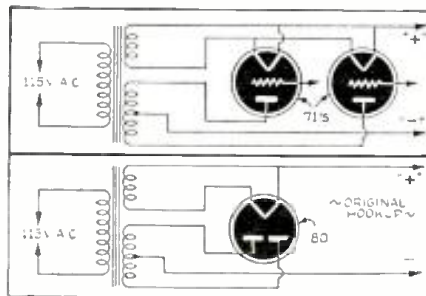

The grid prongs were sawed off and left floating. The original hookup is the second of the 2 shown here.

BURTON E. VAUGHAN,
Berkeley, Calif.

NOISE-PROOFING AUTO ANTENNAS

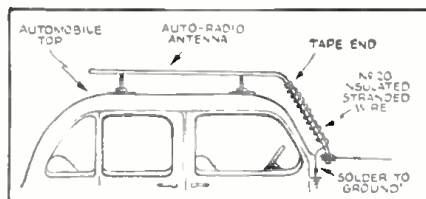

● IF you find that most of your motor interference on "over top" antennas, comes from the section that runs from the Cowl Ventilator to the top of the windshield, try the following remedy:

Solder one end of a length of No. 20 covered stranded wire to the car as a ground, and wrap the wire around the antenna until you get to the bend that goes over the top of the car. In most cases this will eliminate all of your motor interference.

H. T. MIDDLETON,
Cedar City, Vt.

POWER VS. DIODE DETECTION

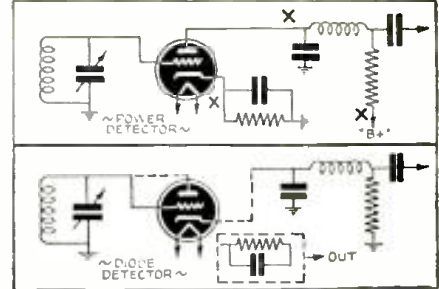

● THERE are many radio sets in use today which have "power" detectors. Although "diode" detectors have less gain and tune more broadly, it is well known that 90% of radio users tune-in to strong nearby stations, and, of course, diodes give high-quality reproduction. The present power detector (triode or pentode) can be used, but sometimes it is difficult to install the diode load resistor in the negative leg of the detector coil, especially in T.R.F. sets. This difficulty is obviated by connecting the load resistor from cathode to ground and the diode works just as well. Break at points marked X in the diagram and reconnect as per dotted lines.

SIGNAL-TEST SERVICING

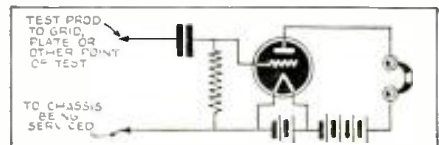

● IN servicing receivers, the Voltage Test method is found inadequate because it does not show up trouble in the antenna coil primary, open or shorted secondary, shorted tuning condensers and trimmers, open bypass condensers, I.F. trimmers, etc.

I use a sort of "Signal Test" unit which is very cheap to make and very effective. It is a 1-tube gridleak detector with earphones but minus the tuning coil and condenser. With it I can follow the signal from the 1st grid lead to the 1st R.F. tube. Shorts and opens would be found immediately. The test prod goes to the plate of that tube, and so on to the other tubes all the way down to the output tube and output transformer. In this way I can locate weak stages, track down sources of excessive hum and find out sources of distortion, etc. The tester is small and light.

Use a type 30 tube, or 1 of the new battery types. Use anywhere from a 12- to a 22-V. "B" battery. Gridleak—1 to 3 megs. Grid condenser—100 to 250 mmf.

J. C. RAVELLE,
Newark, N. J.

STROMBERG-CARLSON NO. 425 FREQUENCY MODULATION RECEIVER AND "CONVERTER"

(Models 425H and 425HB—Chassis 30315 and 30316, respectively) 8-Tube Superhet.; Tuning Range 40 to 44 Megacycles (40,000 to 44,000 kc.); Intermediate Frequency 2.1 Megacycles (2,100 kc.); 105 to 125 V.; A.C. Operation; Power Consumption, 79 W.
(See Data Sheet 271 for other information.)

GENERAL INFORMATION

This receiver is designed for the reception of frequency-modulated broadcast stations only.

The "Armstrong Wide-Swing Frequency Modulation System" used in this receiver is an outstanding development in radio. It makes possible:

1. Static-free reception; both natural and man-made static is virtually eliminated.
2. Noise-free reception; the tube and set noises present in ordinary amplitude modulation receivers are virtually eliminated.
3. Extreme high-fidelity reception; noise-free reproduction of an audio range limited only by the capacity of the human ear or the audio system of the receiver is possible without interference.
4. Interference-free reception; 2 stations cannot be received at the same time.

This system is patented and Stromberg-Carlson manufactures these receivers under an Armstrong license. The Federal Communications Commission has established 5 channels between 40 and 44 megacycles for frequency-modulated transmitting stations. Since this is a comparatively high frequency, the distance over which reception is possible is limited. It should also be noted that the fidelity may be limited by telephone lines, or by program transcriptions, although this condition will, undoubtedly, be improved as time goes on.

USING AS A "CONVERTER"

This receiver may be used as a "converter" (or adapter) so that the audio system of a good high-fidelity receiver of the ordinary amplitude modulation type may be utilized to provide the type of high-fidelity reception only possible with frequency modulation.

It is only necessary to connect the single pin-jack on the back of the chassis (labeled Frequency Modulation Sound Output Jack) to the Phono Input of any other receiver or sound system by means of the cord provided.

In this way, the speaker of the 425 Receiver will act as a "tweeter" or treble speaker and the speaker system of the amplitude modulation receiver will serve as the bass speaker. The balance between the 2 speakers can be controlled by operating the 2 volume controls.

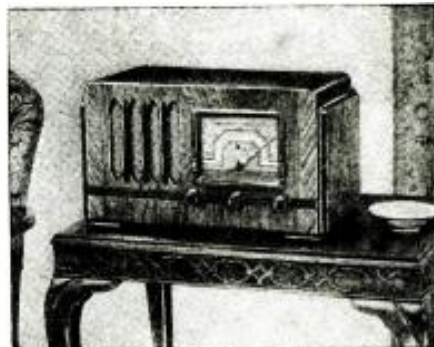

Stromberg-Carlson model 425H F.M. receiver.

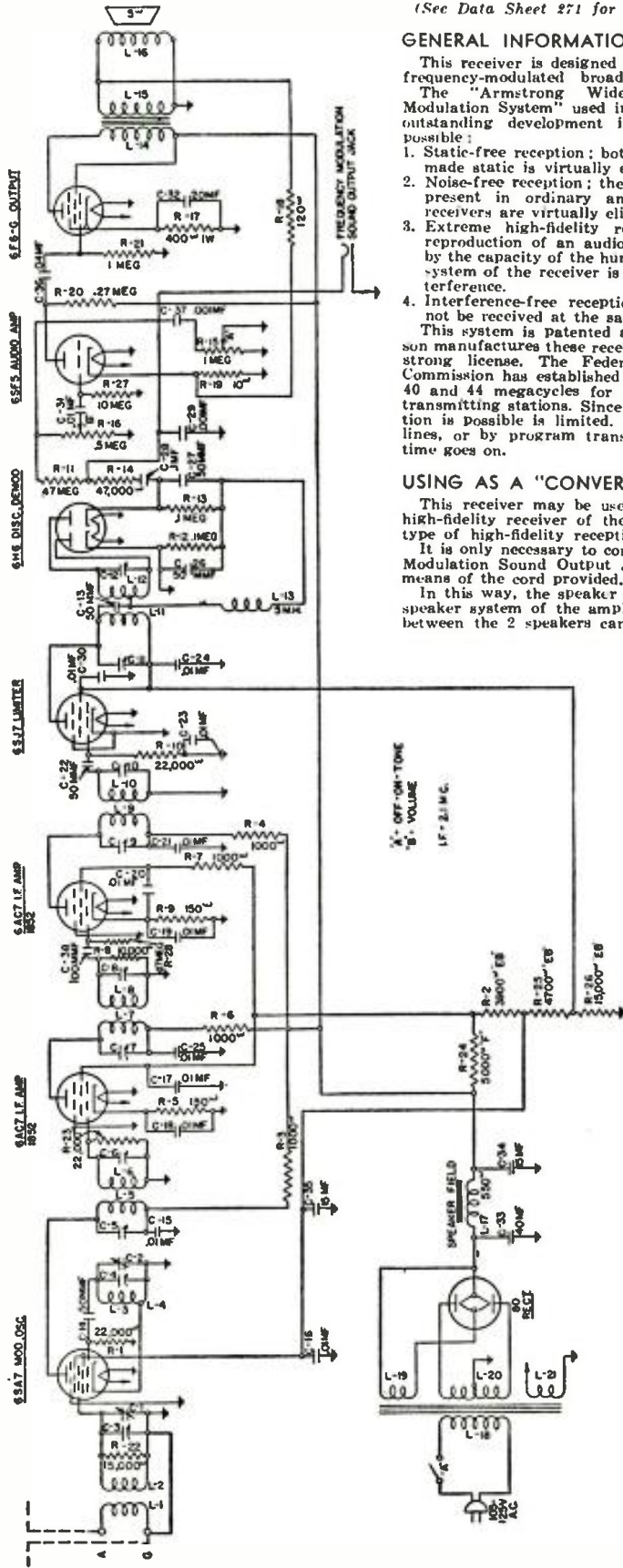

ACCESSORIES

ANTENNA

The proper antenna for frequency modulation reception will depend upon the distance from the stations which it is desired to receive. In some locations, a simple single-wire antenna will be suitable but for best results, the Stromberg-Carlson No. 5-A Antenna Adapter used in conjunction with the No. 5 Antenna to which the amplitude modulation receiver is connected is recommended.

It may also be necessary to utilize a horizontal dipole type of antenna in some locations.

PLAYING RECORDS

If this set is used as a "converter," the phonograph should be attached to the amplitude modulation receiver in the regular way. (The installation of a simple switch will eliminate plugging and unplugging.)

If this set is used as a receiver, the sound output jack may be readily converted to a phonograph input jack by removing the black-white wire which comes from this jack from the terminal block to which it is connected and connecting it to the high side of the volume control (this is the terminal on the volume control to which resistor R-11 is attached).

After this has been done, it is only necessary to plug in a record player, tune to a quiet place on the dial and proceed to operate.

ADJUSTING DIAL LAMP

One dial lamp is used to illuminate the dial on the No. 425 Receiver. To adjust the dial lamp for proper illumination of the dial, slide the lamp socket back and forth on its mounting bracket until maximum illumination is obtained.

NEW SPECIAL ALIGNING INFORMATION!

GENERAL

Never Realign Unless Absolutely Necessary.

All aligning adjustments are carefully made at the factory with special equipment which is designed for aligning frequency modulation receivers. The limitations of commercial oscilloscopes and other ordinary test equipment are such that alignment should not be attempted in the field unless absolutely necessary. If alignment is attempted, it will not be successful unless the instructions which follow are adhered to exactly.

The following equipment will be required:

1. A good signal generator with variable output voltage. (All adjustments are made using an unmodulated signal.)
2. A good center "O" microammeter with 100 divisions on each side of "O". Always have receiver volume control full-on.

See location chart for location of aligning adjustment screws.

I. Discriminator Adjustment.

1. Tune the set to the extreme high-frequency end of the dial (44.5 megacycles).
2. Connect the center "O" microammeter with a 1-megohm resistor in series across one-half of the discriminator load (from ground to the junction of the two 100,000-ohm resistors R12 and R13).
3. Adjust the discriminator alignment screw (L-19) until the microammeter indicates zero.
4. Connect the ground terminal of the signal generator to the ground terminal of the chassis.

(Continued on Data Sheet, No. 271)

STROMBERG-CARLSON NO. 425 FREQUENCY MODULATION RECEIVER AND "CONVERTER"

(Models 425H and 425HB—Chassis 30315 and 30316, respectively) 8-Tube Superhet.; Tuning Range 40 to 44 Megacycles (40,000 to 44,000 kc.); Intermediate Frequency 2.1 Megacycles (2,100 kc.); 105 to 125 V.; A.C. Operation; Power Consumption, 79 W.
(See Data Sheet 270 for other information.)

(Continued from Data Sheet No. 270)

4. Introduce an unmodulated signal of 2,100 kilocycles to the grid (terminal No. 4) of the 6SJ7 limited tube using a 0.1-microfarad condenser in series with the output lead of the signal generator. (Approx. 1 volt signal is necessary.)

5. Adjust the primary of the discriminator transformer for maximum reading of the microammeter.

6. Remove the microammeter and the 1-megohm resistor from the junction of R12 and R13 resistors and connect them across the whole discriminator load (from the high side of the R13 to ground).

7. Adjust the secondary of the discriminator transformer for "O" reading of the microammeter.

II. Intermediate-Frequency Adjustments.

Important: All intermediate frequency adjustments are made using the same unmodulated signal of 2,100 kilocycles. Each I.F. stage must be adjusted independently and in the order given. Do not make any overall adjustments after the previous stage is aligned.

1. Disconnect the jumper wire from the low side of the limiter grid resistor (R10) and connect the microammeter directly to this wire without using the 1-megohm resistor.

2. Connect the output lead from the signal generator with the 0.1-microfarad condenser in series to the grid of the 6AC7 2nd I.F. tube (terminal No. 4).

3. Adjust the secondary of the 3rd I.F. transformer for maximum reading of the microammeter.

4. Adjust the primary of the 3rd I.F. transformer for maximum reading of the microammeter.

5. Connect the output lead from the signal generator with the 0.1-microfarad condenser in series to the grid of the 6AC7 1st I.F. tube (terminal No. 4).

6. Adjust the secondary of the 2nd I.F. transformer for maximum reading of the microammeter.

7. Adjust the primary of the 2nd I.F. transformer for maximum reading of the microammeter.

8. Disconnect the black wire to the antenna coil from the grid terminal of the 6SA7 modulator tube (terminal No. 8) and connect the output lead from the signal with the 0.1-microfarad condenser in series to this terminal.

9. Adjust the secondary of the 1st I.F. transformer for maximum reading of the microammeter.

10. Adjust the primary of the 1st I.F. transformer for maximum reading of the microammeter.

III. Radio-Frequency Adjustments.

(Leave the signal generator connected to the grid of the 6SA7 tube in the same manner as when adjusting the 1st I.F. transformer.)

1. Set the signal generator frequency and the receiver tuning dial to 43 megacycles.

2. Adjust the oscillator aligning condenser located on top of the gang condenser unit for maximum reading of the microammeter.

3. Remove the output lead and the 0.1-microfarad condenser in series with it from the grid of the 6SA7 tube and resolder in its original position the black wire which was removed from this terminal.

4. Replace the 0.1-microfarad condenser in series with the output lead from the signal generator with a 100-ohm carbon-type resistor and connect it to the antenna terminal of the receiver.

5. Adjust the antenna aligning condenser located on top of the gang condenser unit for maximum reading of the microammeter and, at the same time, rotate the gang tuning condenser back and forth through resonance to obtain maximum reading on the microammeter.

IMPORTANT: Do not go back and touch up any adjustments previously made. If the receiver is not in proper alignment after completing the adjustments outlined above, go back and start over again and follow the instructions through to the finish.

6. Re-solder the jumper wire to the low side of the limiter grid resistor (R10).

NORMAL VOLTAGE READINGS

Take all readings with chassis operating and tuned to approximately 43 megacycles—no signal. Use a line voltage of 120 volts, or make allowance for any slight difference.

Use a good high-resistance voltmeter having a resistance of at least 1,000 ohms/volt. Take all D.C. readings on the 500-volt scale except when an asterisk appears. Read from indicated terminals to chassis base. See location chart for position of terminals.

A.C. voltages are indicated by asterisks (**).

Tube Circuit	Cap	Terminals of Sockets						Heater Voltages Between Heater Terminals			
		1	2	3	4	5	6	Sockets	Terminal A.C. Numbers Volts		
6SA7, Osc. and Mod.	—	0	0	+210	+90	0	0	6.3	4	2.7	6.3
6AC7, 1st I.F. Amp. (1852)	—	0	0	0	0	+2*	+118	6.3	+230	2.7	6.3
6AC7, 2nd I.F. Amp. (1852)	—	0	0	0	0	+2*	+115	6.3	+230	2.7	6.3
6SJ7, Limiter	—	0	0	0	0	0	+50	6.3	+57	2.7	6.3
616, Demod. (Discr.)	—	0	0	0	0	-10*	0	6.3	0	2.7	6.3
6SF5, Audio Amp.	—	0	0	0	0	+90	+215	6.3	0	2.7	6.3
6F6G, Output	—	0	0	0	0	+250	+245	6.3	+15*	2.7	6.3
80, Rectifier	+300	+310	+310	+300	—	—	—	6.3	+15*	2.7	6.3

*Read on lowest possible scale of voltmeter.

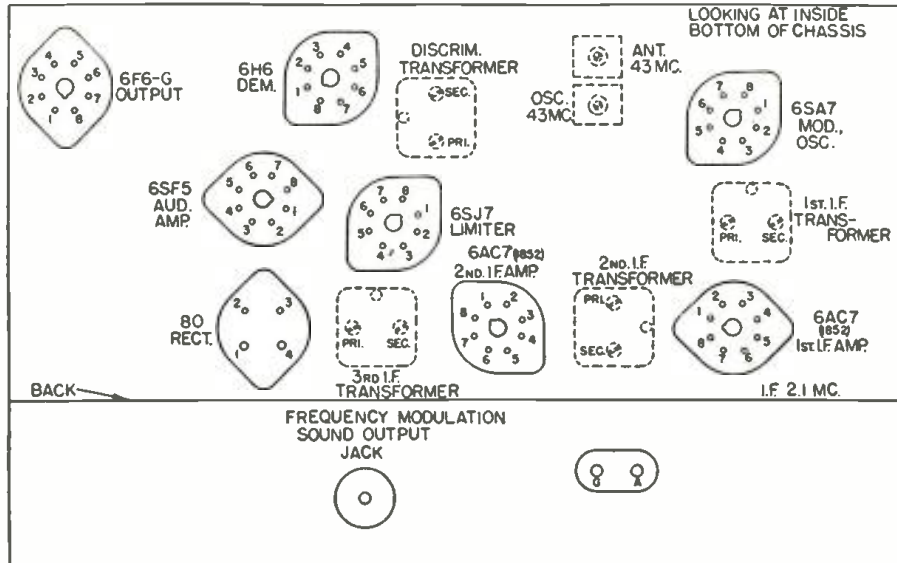

Bottom side of chassis showing locations of trimmers and tube terminal numbering.

CONTINUITY TEST

CAUTION: Remove all tubes and disconnect the receiver from the power supply before making continuity test. Use a good ohmmeter capable of measuring accurately up to several megohms.

The resistances given are often approximate, owing to electrolytic condensers in the circuit. When this is the case, be sure to reverse the test leads and read the highest resistance.

Read from indicated terminals to chassis base.

Tube Circuit	Cap	TERMINALS OF SOCKETS								
		1	2	3	4	5	6	7	8	
6SA7, Osc. and Mod.	—	∞	∞	30000*	20000*	20000*	∞	∞	∞	30000*
6AC7, 1st I.F. Amp. (1852)	—	∞	∞	∞	150*	27000*	∞	∞	∞	30000*
6AC7, 2nd I.F. Amp. (1852)	—	∞	∞	∞	50000*	150*	30000*	∞	∞	30000*
6SJ7, Limiter	—	∞	∞	∞	26000*	∞	18000*	∞	∞	18000*
616, Demod. (Discr.)	—	∞	∞	∞	90000*	∞	30000*	0	∞	180000*
6SF5, Audio Amp.	—	∞	10*	10M	∞	30000*	30000*	∞	∞	∞
6F6G, Output	—	∞	∞	30000*	30000*	1M	0	∞	∞	400*
80, Rectifier	—	100*	30000*	30000*	100*	∞	∞	∞	∞	∞

Symbols used are as follows: ∞—ohms; M—megohms; ∞—short; 0—open.

OTHER TESTS NOT SHOWN ON CHART

- Antenna terminal to chassis base....."short"
- Ground terminal to chassis base....."short"
- F.M. Sound Output Jack to chassis base.....1 megohm
- Terminal of A.C. plug to chassis base....."open"
- Between terminals of A.C. plug:
 - A.C. switch open....."open"
 - A.C. switch closed......6 ohms
- R.F. coil tests measured directly across R.F. coil terminals.
 - L1—0.2-ohm, L2—"short", L3—"short", L4—"short", L13—55 ohms.

This is the first detailed description of procedure on servicing *frequency modulation* receivers so far presented in *Radio-Craft*. Although few of these receivers have as yet been sold, taking all makes together, in comparison with the number of amplitude modulation receivers sold previously, either in total or during the same sales period, many Servicemen will want to analyze the circuits and study the servicing procedure so that they will not be caught unprepared when frequency modulation receivers arrive in their neighborhood and require installation or service. It is for these foresighted technicians that Data Sheets Nos. 270 and 271 have been prepared. (For additional "F.M." data, see "Frequency-Modulated Programs on Your Present Receiver!", in the Dec. 1939 and Jan. 1940 issues of *Radio-Craft*.)

Mailbag



"ELECTRONIC GUITAR"

Dear Editor:

That article about electric guitars (in the November, 1939, issue) was OK but just 3 yrs. too late, for my part. Three years ago I had a yen for an Hawaiian guitar but couldn't find any dope about the pickup.

So I started experimenting and after trying all sorts of magnets and coils, finally hit on the type I am now using (see drawing). It is the only one that I have had that would give equal intensity on all strings. As the drawing shows, a split magnet would make it easier to replace a string, but strings don't have to be changed very often. The coils, from old-time telephone hand-receivers, are sawed-off and soldered to the bottom pole-piece.

Now the one in the magazine is all right for Spanish style (plectrum) because the strings vibrate quite a bit but on Hawaiian the pickup has to be as close to the bridge as possible, and those strings just don't shimmy much.

Being in the sheet metal business since 1923, it was a cinch to make the guitar out of metal; all I used from a real guitar was the neck! The guitar body can be any shape, just so it is deep enough to set the magnet in. My guitar is composed of galvanized iron, copper, and stainless steel, and even some sheet brass, but the instrument can also be carved out of wood, etc. That's enough about the guitar; it can be made any way the builder sees fit.

Now there is one thing the article forgot to mention, and that is, that for any results whatsoever you must have strings that are magnetic. Nor will ordinary strings work satisfactorily. I use Rickenbacker strings, but there are many others on the market that are also good, but I will say again you have to have special strings. I tried the

common strings and I feel I know what I am popping-off about.

There is one more thing, if a person doesn't have a high-gain amplifier, there is no use trying to make a guitar. Just forget about it. One amplifier I have has a 2A6, 53, 56, and p-p. 2A5's. One channel straight through and another coming in on the other half of the 53. The other amplifier is a rebuilt Edison 8P; a 57-53 hooked in parallel, and p-p. 45's. This amplifier has only one channel for domestic use.

GILBERT VIVROUX, W5ALN,
Seguin, Texas.

Thanks a lot for your very pertinent comments, Mr. Vivroux. We are sure many RADIO-CRAFT readers will be interested to learn of these tips.

RE: "WANTS TRANSMITTER ARTICLES" —YES

Dear Editor:

I was very pleased when I saw an article in your last issue by Kenneth S. Babb, because he hit the nail on the head. In my opinion, a good transmitter design or two is the main attraction of any radio magazine. I would like to see a medium-power (100 watts), 100 per cent modulated transmitter of conventional design; and so would others whom I know.

E. G.,
Rock Island, Ill.

—YES

Dear Editor:

Not so long ago, you used to have a very good magazine. Since that time, your magazine has taken a tendency toward another branch of radio, in fact, you have fallen

over backwards to stress the servicing end of radio. From cover to cover, one can read various articles on other phases of this broad field, but the main backbone of them all is service and the Serviceman.

I have had my amateur license for only one year, but I believe that most "hams" would string along for more features for the amateur. These could include transmitter construction data, receivers, etc. As I remember it, you published many interesting articles on these subjects a few years back. Why not reform and make your publications include more for the amateur? You would have a regular customer here.

LESLIE DIEHL, JR. (W8SPL).
Dayton, Ohio.

—NO

Dear Editor:

I have up to the present time been an avid reader of *Radio-Craft*. Of all the radio magazines, *Radio-Craft* entirely fills the needs of a radio Serviceman. It has followed a good sane system of putting in the right articles for our interest.

However, I differ in viewpoint with Kenneth S. Babb in asking for an article on a transmitter. Why waste a page or two in an article that will not benefit the Serviceman? There are several magazines that deal entirely with amateur rigs.

(I liked your former magazine binding better than the present but that will not stop me from remaining a subscriber.)

I hope that *Radio-Craft* will continue to cater to the Serviceman.

A. K. GIBSON,
Port Hammond,
British Columbia.

—NO

Dear Editor:

It was a lucky incident when I picked up a copy of *Radio-Craft* for November, 1939, while waiting for a friend.

During the past several years I have been hoping to find a radio magazine which was not full of amateur's gear and what nots. Now I know there are some 50,000 hams on this sphere, and that they really are the foundation of radio. But—there are also a large number of Servicemen, radio hobbyists, and experimenters who do not include Xmitting in their interest. Personally, I should like to have a good phone rig, but with golf, photography, speedboating, girls, and radio-phonograph interest,

(Continued on page 496)

Let's have some Xmitter circuits
YANKEETOWN U.S.A. FLORIDA
Confirming Disc. Radio-Craft Page 275 Nov. issue
Band Meters RST QSA r Conditions.....
W4FWV
Receiver PR-15 Xmttr 6C5-646-809-813
Remarks PSE QSL TNX VY 73 C. E. COTTRELL

Guitar pickup from telephone coils. The center of the coils, pole to pole, is 7/16-in. This is just the correct spacing for strings, at the bridge.

According to his card, which has a red rectangle around the call letters, Mr. Cottrell has a pretty nice rig, with a 100-watt 813 final.

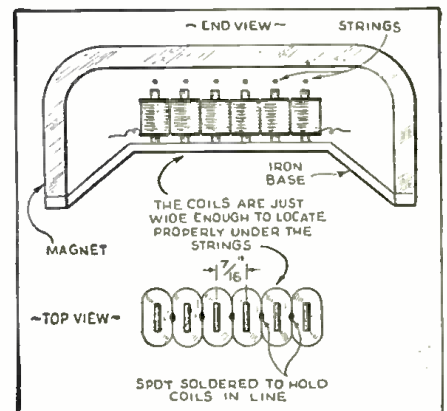

All the worthwhile
Radio Trade News
of the past Month—
Digested for busy
radio men.

RADIO Trade Digest

A PLEDGE: — To
print the important
news of the radio
industry; to review
major news events;
to help point a path
to radio profits.

IMPORTANT HAPPENINGS OF THE MONTH IN THE RADIO INDUSTRY

No. 18

FEBRUARY, 1940

No. 18

"FREEDOM OF SPEECH" FIGHT ON AIRWAVES

*NAB Code Receives Approval of
American Civil Liberties
Union. 'Nuf Sed*

Far from infringing the freedom of speech, the code proposed by the Nat'l Assoc. of Bestrs has received approval from the Nat'l Council of Catholic Men, American Civil Liberties Union, Federal Council of the Churches of Christ in America, National Council of Women, General Federation of Women's Clubs, Boys' Clubs of America, Assoc. of National Advertisers, American Assoc. of Advertising Agencies, & National Education Assoc.

With groups like that behind it, it would appear that congrats. are due to the NAB Code Committee despite the fact that John F. Patt, v.-p. of Detroit's WJR & Cleveland's WGAR, states that the code violates freedom of speech & enters the realm of censorship. (Note: WJR carries Father Coughlin and is in fact the point of origin of his broadcast.)

Advantage claimed for code is that ideas without money to back them should get same radio break as ideas with big war chest. Code in effect carries the F.C.C. ruling that when station time is given free to one political party, other parties must be afforded equal facilities, a step farther. NAB believes that if time is available only to organizations which can buy it, a distorted picture of American thought may result. Text of Edgar Bill's speech on this subject obtainable from NAB is well worth reading.

MFRS' REPS NOW FORM "REPER" ASSN NEW GROUP MEETS WITH SERVICEMEN

*10-Car Caravan Tours 3 Cities; Members Give Dinner
To Local Jobbers & RSA Chapters; Discuss
Problems Affecting Radio Industry*

NEW RCA FACTORY HEAD



Harry L. Sommerer, for 30 yrs. with RCA, has been appointed mgr. of mfg. for the co. & will supervise the plants at Camden & Harrison, N. J., Hollywood, Calif., & Indianapolis, Ind. Born in Phila., Mr. Sommerer became a bookkeeper for Victor in 1909. Later he shifted to the purchasing dept. where he became gen. purchasing agt. Early in '30 he was made managing dir. of Victor Talking Machine Co. of Japan & when this was sold to the Japanese in '37 he returned to Camden, later becoming ass't to the exc. v.-p. His H.Q. will be in that city.

Mfrs.' reps. from Minneapolis and St. Paul, who have organized as "The Repers" formed a 10-car caravan to visit Duluth, Minn.; Fargo, N. D.; and Sioux Falls, S. D. Reps. were each assigned a table in a hotel Banquet Hall to show their samples & literature. All Servicemen & jobbers in the trading area were invited to attend a dinner and round-table discussion. Mfrs.' and jobbers' problems were discussed with the Servicemen, resulting in a better understanding of the problems facing other branches of the industry.

NEW CHAPTER AFFILIATIONS

Local Chapters of RSA have been established in Amsterdam, New York; Marinette, Wis., and Minneapolis, Minn.

GUARANTEE SERVICE PLAN

More and more chapters of the RSA are completing the necessary work under the Guarantee Service Plan of RSA, which guarantees the work of the individual Servicemen and protects the public from unscrupulous operators. Members are reporting increased business.

NAB-RSA JOINT PROMOTION

Some 25 chapters of the RSA have been participating in the NAB-RSA Joint Promotion for selling the American system of broadcasting, and bettering the radio service business.

FACTORY HAND WORKS FOR Ph.D.



Margaret Kellar, assembly line hand in the Farnsworth plant at Marion, Ind., has left the factory to return to Indiana U. for further studies toward a Ph.D. degree. Miss Kellar already holds 2 degrees, having earned her way as dishwasher, waitress, tutor, & ass't instructor. She hopes to become a math. prof.

DYNAMIC DEMONSTRATOR SOLVES SERVICE

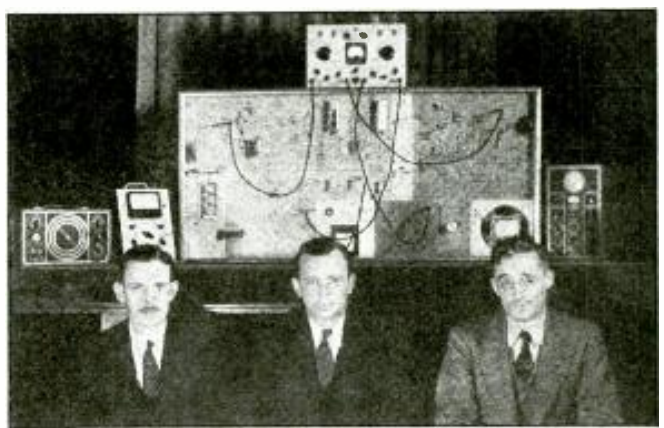

G. W. Kimball, Wm. H. Bohlke & John Meagher (l. to r.) are shown above with new RCA "dynamic demonstrator" unit, a radio receiver so mounted that components and diagram are visible to audience. Instrument simulates all types of receiver faults & Chanalyst, atop it, demonstrates how to locate & correct them!

MORE HELPS TO MORE BUSINESS AND MORE PROFITS

Personal

OFFICIAL RADIO SERVICE ANALYSIS AND TEST REPORT

Name of Set _____ Date _____
 Model _____ Serial No. _____
 Owner _____ Phone _____
 Address _____

**INSET ON NATIONAL UNION TUBES AND CONDENSERS
 LONG LIFE COMPLETE RENOVATION SERVICE FOR ALL RADIOS**

I. TUBES

Radio	Year	Set No.	Model	Serial No.	Set No.	Model	Serial No.
1							
2							
3							
4							
5							
6							
7							
8							
9							
10							
11							
12							
13							
14							
15							
16							
17							
18							
19							
20							
21							
22							
23							
24							
25							
26							
27							
28							
29							
30							
31							
32							
33							
34							
35							
36							
37							
38							
39							
40							
41							
42							
43							
44							
45							
46							
47							
48							
49							
50							
51							
52							
53							
54							
55							
56							
57							
58							
59							
60							
61							
62							
63							
64							
65							
66							
67							
68							
69							
70							
71							
72							
73							
74							
75							
76							
77							
78							
79							
80							
81							
82							
83							
84							
85							
86							
87							
88							
89							
90							
91							
92							
93							
94							
95							
96							
97							
98							
99							
100							

CONDENSERS

1. 500K
 2. 100K
 3. 50K
 4. 25K
 5. 10K
 6. 5K
 7. 2.5K
 8. 1K
 9. 500
 10. 250
 11. 100
 12. 50
 13. 25
 14. 10
 15. 5
 16. 2.5
 17. 1
 18. 500
 19. 250
 20. 100
 21. 50
 22. 25
 23. 10
 24. 5
 25. 2.5
 26. 1
 27. 500
 28. 250
 29. 100
 30. 50
 31. 25
 32. 10
 33. 5
 34. 2.5
 35. 1
 36. 500
 37. 250
 38. 100
 39. 50
 40. 25
 41. 10
 42. 5
 43. 2.5
 44. 1
 45. 500
 46. 250
 47. 100
 48. 50
 49. 25
 50. 10
 51. 5
 52. 2.5
 53. 1
 54. 500
 55. 250
 56. 100
 57. 50
 58. 25
 59. 10
 60. 5
 61. 2.5
 62. 1
 63. 500
 64. 250
 65. 100
 66. 50
 67. 25
 68. 10
 69. 5
 70. 2.5
 71. 1
 72. 500
 73. 250
 74. 100
 75. 50
 76. 25
 77. 10
 78. 5
 79. 2.5
 80. 1
 81. 500
 82. 250
 83. 100
 84. 50
 85. 25
 86. 10
 87. 5
 88. 2.5
 89. 1
 90. 500
 91. 250
 92. 100
 93. 50
 94. 25
 95. 10
 96. 5
 97. 2.5
 98. 1
 99. 500
 100. 250

II. TUBES

1. 6X4
 2. 6X5
 3. 6X6
 4. 6X7
 5. 6X8
 6. 6X9
 7. 6X10
 8. 6X11
 9. 6X12
 10. 6X13
 11. 6X14
 12. 6X15
 13. 6X16
 14. 6X17
 15. 6X18
 16. 6X19
 17. 6X20
 18. 6X21
 19. 6X22
 20. 6X23
 21. 6X24
 22. 6X25
 23. 6X26
 24. 6X27
 25. 6X28
 26. 6X29
 27. 6X30
 28. 6X31
 29. 6X32
 30. 6X33
 31. 6X34
 32. 6X35
 33. 6X36
 34. 6X37
 35. 6X38
 36. 6X39
 37. 6X40
 38. 6X41
 39. 6X42
 40. 6X43
 41. 6X44
 42. 6X45
 43. 6X46
 44. 6X47
 45. 6X48
 46. 6X49
 47. 6X50
 48. 6X51
 49. 6X52
 50. 6X53
 51. 6X54
 52. 6X55
 53. 6X56
 54. 6X57
 55. 6X58
 56. 6X59
 57. 6X60
 58. 6X61
 59. 6X62
 60. 6X63
 61. 6X64
 62. 6X65
 63. 6X66
 64. 6X67
 65. 6X68
 66. 6X69
 67. 6X70
 68. 6X71
 69. 6X72
 70. 6X73
 71. 6X74
 72. 6X75
 73. 6X76
 74. 6X77
 75. 6X78
 76. 6X79
 77. 6X80
 78. 6X81
 79. 6X82
 80. 6X83
 81. 6X84
 82. 6X85
 83. 6X86
 84. 6X87
 85. 6X88
 86. 6X89
 87. 6X90
 88. 6X91
 89. 6X92
 90. 6X93
 91. 6X94
 92. 6X95
 93. 6X96
 94. 6X97
 95. 6X98
 96. 6X99
 97. 6X100

III. TUBES

1. 6X4
 2. 6X5
 3. 6X6
 4. 6X7
 5. 6X8
 6. 6X9
 7. 6X10
 8. 6X11
 9. 6X12
 10. 6X13
 11. 6X14
 12. 6X15
 13. 6X16
 14. 6X17
 15. 6X18
 16. 6X19
 17. 6X20
 18. 6X21
 19. 6X22
 20. 6X23
 21. 6X24
 22. 6X25
 23. 6X26
 24. 6X27
 25. 6X28
 26. 6X29
 27. 6X30
 28. 6X31
 29. 6X32
 30. 6X33
 31. 6X34
 32. 6X35
 33. 6X36
 34. 6X37
 35. 6X38
 36. 6X39
 37. 6X40
 38. 6X41
 39. 6X42
 40. 6X43
 41. 6X44
 42. 6X45
 43. 6X46
 44. 6X47
 45. 6X48
 46. 6X49
 47. 6X50
 48. 6X51
 49. 6X52
 50. 6X53
 51. 6X54
 52. 6X55
 53. 6X56
 54. 6X57
 55. 6X58
 56. 6X59
 57. 6X60
 58. 6X61
 59. 6X62
 60. 6X63
 61. 6X64
 62. 6X65
 63. 6X66
 64. 6X67
 65. 6X68
 66. 6X69
 67. 6X70
 68. 6X71
 69. 6X72
 70. 6X73
 71. 6X74
 72. 6X75
 73. 6X76
 74. 6X77
 75. 6X78
 76. 6X79
 77. 6X80
 78. 6X81
 79. 6X82
 80. 6X83
 81. 6X84
 82. 6X85
 83. 6X86
 84. 6X87
 85. 6X88
 86. 6X89
 87. 6X90
 88. 6X91
 89. 6X92
 90. 6X93
 91. 6X94
 92. 6X95
 93. 6X96
 94. 6X97
 95. 6X98
 96. 6X99
 97. 6X100

IV. TUBES

1. 6X4
 2. 6X5
 3. 6X6
 4. 6X7
 5. 6X8
 6. 6X9
 7. 6X10
 8. 6X11
 9. 6X12
 10. 6X13
 11. 6X14
 12. 6X15
 13. 6X16
 14. 6X17
 15. 6X18
 16. 6X19
 17. 6X20
 18. 6X21
 19. 6X22
 20. 6X23
 21. 6X24
 22. 6X25
 23. 6X26
 24. 6X27
 25. 6X28
 26. 6X29
 27. 6X30
 28. 6X31
 29. 6X32
 30. 6X33
 31. 6X34
 32. 6X35
 33. 6X36
 34. 6X37
 35. 6X38
 36. 6X39
 37. 6X40
 38. 6X41
 39. 6X42
 40. 6X43
 41. 6X44
 42. 6X45
 43. 6X46
 44. 6X47
 45. 6X48
 46. 6X49
 47. 6X50
 48. 6X51
 49. 6X52
 50. 6X53
 51. 6X54
 52. 6X55
 53. 6X56
 54. 6X57
 55. 6X58
 56. 6X59
 57. 6X60
 58. 6X61
 59. 6X62
 60. 6X63
 61. 6X64
 62. 6X65
 63. 6X66
 64. 6X67
 65. 6X68
 66. 6X69
 67. 6X70
 68. 6X71
 69. 6X72
 70. 6X73
 71. 6X74
 72. 6X75
 73. 6X76
 74. 6X77
 75. 6X78
 76. 6X79
 77. 6X80
 78. 6X81
 79. 6X82
 80. 6X83
 81. 6X84
 82. 6X85
 83. 6X86
 84. 6X87
 85. 6X88
 86. 6X89
 87. 6X90
 88. 6X91
 89. 6X92
 90. 6X93
 91. 6X94
 92. 6X95
 93. 6X96
 94. 6X97
 95. 6X98
 96. 6X99
 97. 6X100

V. TUBES

1. 6X4
 2. 6X5
 3. 6X6
 4. 6X7
 5. 6X8
 6. 6X9
 7. 6X10
 8. 6X11
 9. 6X12
 10. 6X13
 11. 6X14
 12. 6X15
 13. 6X16
 14. 6X17
 15. 6X18
 16. 6X19
 17. 6X20
 18. 6X21
 19. 6X22
 20. 6X23
 21. 6X24
 22. 6X25
 23. 6X26
 24. 6X27
 25. 6X28
 26. 6X29
 27. 6X30
 28. 6X31
 29. 6X32
 30. 6X33
 31. 6X34
 32. 6X35
 33. 6X36
 34. 6X37
 35. 6X38
 36. 6X39
 37. 6X40
 38. 6X41
 39. 6X42
 40. 6X43
 41. 6X44
 42. 6X45
 43. 6X46
 44. 6X47
 45. 6X48
 46. 6X49
 47. 6X50
 48. 6X51
 49. 6X52
 50. 6X53
 51. 6X54
 52. 6X55
 53. 6X56
 54. 6X57
 55. 6X58
 56. 6X59
 57. 6X60
 58. 6X61
 59. 6X62
 60. 6X63
 61. 6X64
 62. 6X65
 63. 6X66
 64. 6X67
 65. 6X68
 66. 6X69
 67. 6X70
 68. 6X71
 69. 6X72
 70. 6X73
 71. 6X74
 72. 6X75
 73. 6X76
 74. 6X77
 75. 6X78
 76. 6X79
 77. 6X80
 78. 6X81
 79. 6X82
 80. 6X83
 81. 6X84
 82. 6X85
 83. 6X86
 84. 6X87
 85. 6X88
 86. 6X89
 87. 6X90
 88. 6X91
 89. 6X92
 90. 6X93
 91. 6X94
 92. 6X95
 93. 6X96
 94. 6X97
 95. 6X98
 96. 6X99
 97. 6X100

VI. TUBES

1. 6X4
 2. 6X5
 3. 6X6
 4. 6X7
 5. 6X8
 6. 6X9
 7. 6X10
 8. 6X11
 9. 6X12
 10. 6X13
 11. 6X14
 12. 6X15
 13. 6X16
 14. 6X17
 15. 6X18
 16. 6X19
 17. 6X20
 18. 6X21
 19. 6X22
 20. 6X23
 21. 6X24
 22. 6X25
 23. 6X26
 24. 6X27
 25. 6X28
 26. 6X29
 27. 6X30
 28. 6X31
 29. 6X32
 30. 6X33
 31. 6X34
 32. 6X35
 33. 6X36
 34. 6X37
 35. 6X38
 36. 6X39
 37. 6X40
 38. 6X41
 39. 6X42
 40. 6X43
 41. 6X44
 42. 6X45
 43. 6X46
 44. 6X47
 45. 6X48
 46. 6X49
 47. 6X50
 48. 6X51
 49. 6X52
 50. 6X53
 51. 6X54
 52. 6X55
 53. 6X56
 54. 6X57
 55. 6X58
 56. 6X59
 57. 6X60
 58. 6X61
 59. 6X62
 60. 6X63
 61. 6X64
 62. 6X65

AN EDITORIAL

By Artie Dee

Elsewhere in these pages you will see news items on the planned formation of national television networks. There is also a report that shortly after the first of the year, the prices of television receivers will take a sharp drop. These 2 occurrences will put you pleasantly on the pocketbook—IF—

Price Drop?

Television, the newest of the communication arts, has a wide public appeal but only if, as has been said before, sufficiently good programs are widely enough available to large groups of people. The drop in price, coupled with the inception of the networks, will make programs available over larger areas and to more people in each area. The one factor which remains is program excellence.

It should be obvious that customers will buy television receivers only if they are assured of consistently good programs of entertainment. The stations themselves cannot be expected to bear the entire cost of program production and presentation as they have been doing thus far.

Sponsors Needed!

Advertisers who sponsor ordinary broadcasts do so because in that way their message can reach millions — in television they could reach only hundreds, or at the best, a few thousand.

The manufacturers of television receivers stand to make important money when the public goes television mad. It would seem logical that those who plan to manufacture television receiving equipment should take the step necessary to make such equipment sell.

RTD therefore makes the suggestion that all manufacturers producing or planning the production of television receivers have a little get-together and appropriate a few hundred dollars a week, each, to put on the air the types of programs which will make business for themselves and their dealers.

How about it, boys?



TELEVISION NETWORKS LOOMING! NBC is beginning to reveal plans for a nation-wide telly net; G-E has discussed plans for a N.Y. State telly net; CBS is very hush-hush about plans to open a Philly telly station linked to their N.Y. station soon . . . Similar network problems are being worked out by G-E & the Yankee Net for freq. mod. broadcasts . . . The Majestic Radio & Telly Corp. mixup is being well straightened

out, as Claude A. Roth has qualified as trustee; biz going on as usual . . . RCA's "dynamic demonstrator" creates service problems & then shows Servicemen how to solve 'em! . . . Sales mgr. T. A. Kennally of Philco points out that the War is making shortwave an increasingly good selling point. . . Radio Masters of the Air is name of new weekly bcst over WCNW (Bklyn, N. Y.) 1,500 Kc., every Wed. 10 to 10:30 P.M. Jack Grand of Sun Radio, N. Y. C., director, says it is devoted to welfare of Servicemen. Tune-in "your own" program, Mr. Serviceman.

Specialty Prods. Div., a new branch of Western Electric, will handle the Co.'s best, sound, & hearing-aid lines as well as aviation, marine and police radio. . . NAB local stations will urge listeners to keep receivers up to snuff—the tieup was made by RSA. . . A mutual licensing agreement between RCA & Farnsworth Corp. will help both cos'. telly & radio lines. . . Lucite, a new plastic, is said to be high-efficiency insulation on auto-radio & other antennas. . . Top award in the 4th Annual Modern Plastics Competition was won by RCA Victor's ready-record rack.

Signode Steel Strapping Co. features Stewart-Warner packing in its house organ. . . Arcturus is branching out—their Mir-O-Ray reflecting material is being used for signs on Henry Hudson Pkway. . . Art Moss of N.R.P.D.A., just back from a 5-State trip, reports 4 new members and an enthusiastic jobber reception of the new setup in the replacement tube market. . . Philco plants broke all previous records for the 6th consecutive week. . . Remember The City of Flint, seized by the Nazis and

later released? Well, part of the cargo consisted of National Union tubes bound for Fire. . . A.M.A. pub. "Automobile Facts" states that motor cars generated more power than all other producers combined; has anybody the facts on radio bcstng?

The new Du Mont electronic switch makes it feasible to amplify D.C. signals through A.C. circuits. . . Century Radio Co., Sylvania distrib. in Phila. has celebrated 5th anniversary. . . And about the same time Stromberg-Carlson celebrated its 45th anniversary. . . G-E is licensed to mfr. & sell telly & freq. mod. transmitter & tubes. . . Title 47, "Telecommunication," is an interesting bulletin obtainable from the U.S. Govt. Printing Office (Federal Register), Washington, D.C. . . Needle-driven cone speaker marks the RCA Victrola Jr. electric-motor phono—selling under \$5—fine for kids even if Christmas is past.

Flush! John E. Otterson, pres. of Radio Wire Television Corp. of America sold his interest & is no longer connected with the management; A. W. Pletman, v.-p., has taken over management. (Wonder what this all means?) Incidentally the co. has active centers in N.Y.C., Boston, Newark, Pittsburgh Phila. Atlantic City and Wash.

Changes & New Addresses

Where to Reach Old and New Companies

LITTELFUSE, Inc., has moved to larger quarters at 4757 Ravenswood Ave., Chicago, Ill.; biz is up 35% over last yr.

ALLIED RECORDING PRODUCTS CO. offices & plant are now in larger quarters at 21-09 43 Ave., Long Island City, N. Y.

FCC INSPECTS NEW TELLY FIELD JOB

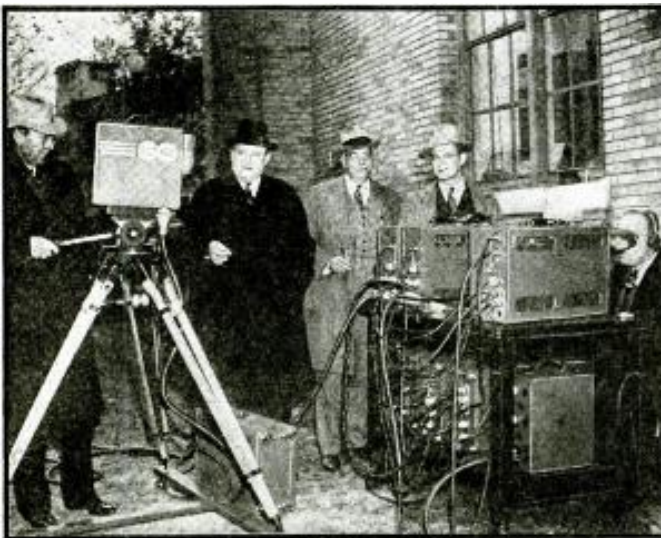

FCC Commissioners James Lawrence Fly, chairman, at camera; standing, left to right, Thad H. Brown, Norman S. Case, and T. A. M. Craven have gander at RCA's latest lightweight portable telly field equip. Various components are available in small carrying cases, weighing from 35 to 72 lbs., each. Low cost of this telly gear will probably put more sight stations on air—sooner. Which should mean more telly set sales for you!

SOUND TRUCK TAMES AUTO "COWBOYS"



Wild motorists, known to cops as "cowboys", to Shell Oil Co. as "screw-drivers," receive visual message from puppet show in truck above, audible message from Lafayette model 269-T mobile amplifier installed in truck. Power from 1,500-W. generator provides system's power, floodlighting, stage-lighting, etc. Job has record player, mixer, fader, etc. Output 20 W. to two 10-in. speakers.

2 WINNERS IN MODERN PLASTICS COMPETITION



Slim & distinguished, this Stewart-Warner Air-Pal copped a prize in the Modern Plastics competition. Carrying case provided for portability; pencil indicates size.

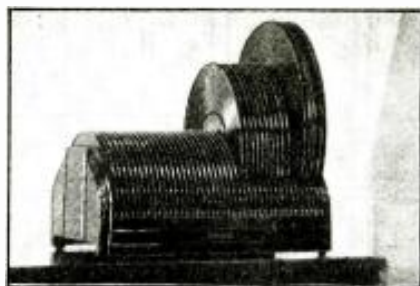

High award winner in same competition is RCA's phono record rack, which stores records safely & compactly with convenient index system to locate any selection wanted.

Salesman Sam Says:—

Data issued by U. S. Govt. Far more detailed information is available from the Bureau of Foreign & Domestic Commerce, Washington, D.C. Publications to request are: World Radio Markets covering countries wanted & The Electrical & Radio World Trade News.

BOLIVIA—20,000 sets in use by 3,000,000 population of whom 85% are not possible purchasers, American sets preferred but sales do not exceed 800 per yr.

GERMANY—16,000,000 sets in use by 70,000,000 population. Use your own judgement.

ALGERIA—100,000 sets in use by 7,300,000 population. War annihilated market.

CUBA (Supplementary report just issued)—Deals with new regulations & may be ordered as Cuba Supplement 267-268.2.

MEXICO—450,000 sets in use by 19,500,000 population, only about 10% of which are prospects. Only 37,126 units were imported in 1938—a drop of 63.2% from 1937. However imports during first 6 mo. of 1939 were 31,798 units valued at more than 3,000,000 pesos (about \$600,000 U.S.). Low-price 5-tube table sets most popular, with 6-tube, 3-band jobs second. Tropical treatment not necessary. Demand for battery sets growing. Preferred wavelength ranges are from 13 or 16 to 550 meters. Most territories have 110-125 V., 50-60 cycle A.C., except Merida which has 220 V., 60 cycle. Standard U.S. plugs feed outlets.

YUGOSLAVIA—147,572 sets in use by 15,600,000 population, 70% of whom are prospects. About 64% of the sets are in the Belgrade area. Annual sale about 20,000 sets; highest in winter; 5-tube supers. preferred. About 80% of sets work on 220 V., 50-cycle A.C.

CHOSSEN—135,000 sets in use by 22,600,000 population, about 20% of which are possible prospects; 3/4 of tubes sold are Japanese make. Set sales in 1938 were 20,000, principally 4-tube table models with magnetic speaker, retailing from 7 to 9 dollars. Most current 100 V., 60 cycle. Restrictions now clamped on.

CHINA—500,000 sets in use by 285,000,000 population, only about 15% of which are still prospects. Due to War conditions, market somewhat hazardous, but possibly worth investigation.

NETHERLANDS WEST INDIES—2,782 sets in use by 86,500 population, only about 15% of which may be considered possible customers; 7-11 tube table sets for medium and short waves, selling about \$95 preferred.

FRENCH GUIANA—80 sets in use by 30,876 population. Don't bother.

CANARY ISLANDS—6,547 sets in use by 650,000 population. Prior to Spanish Civil War, sales were about 500 annually; during 1938 about 100 were imported. According to report, dated late Oct., sales were at standstill due to lack of stock. Local preference for 5-8 tube table models.

NEW ZEALAND—321,398 sets in use by 1,600,000 population. Times have been prosperous recently so market should be good if shipment can be arranged under War conditions but, 85% of homes now have radios; 5-7 tube table models for local reception in most demand but good sales also had 6-7 tube all-wave consoles. Dials should be marked in ke.

CANADA—Supplementary report giving local regulations may be had by ordering Canada Supplement 196.1-196.3.

PANAMA—12,000 sets in use by 550,000 population. Sets costing \$50 to \$100 equipped with shortwave bands preferred.

PORTUGAL—81,171 sets in use by 6,780,000 population, at least 50% of which are not prospects; 20,000 sets were sold in 1938 but sales dropped off about 20% in the 1-3 quarter of 1939. Shipping hazardous due to blockades & mines.

PORTUGUESE GUINEA—241 sets in use by 400,000 population. Only 45 sets were imported in 1938. Ho-hum.

NEW ZEALAND—Supplementary report gives recent regulations. May be ordered as New Zealand Supplement 597-598.2.

TONGA—80 sets in use by 30,000 population, only about 2% of which are possible prospects. Sole demand is for battery sets from 4 to 8 tubes.

AUSTRALIA—1,250,000 sets in use by 7,000,000 population. 1939 sales will reach 150,000 units according to local estimates. Greatest de-

SHOP COAT SAVES CLOTHES



Professional touch is given to Service Shop when employees wear Sylvania's new uniform-like shop coat. Better yet, it helps keep clothing from getting soiled or torn.

mand for 5-tube table models, with American sets selling well. Most districts have 240 V., 50 cycle A.C. This report worth studying.

PARAGUAY—8,000 sets in use by 900,000 population. Market reaching saturation point, consequently tough competition, made harder by fact that only about 10% of population earns more than \$20 a month, so—.

NICARAGUA—4,000 sets in use by 1,000,000 population, 90% of whom are best reached from West Coast. 1939 reported duldest season in 10 yrs.—and only about 300 sets were imported in 1938.

HONG KONG—11,620 sets in use by 850,000 population. Demand increasing annually.

HONDURAS—15,000 sets in use by 1,000,000 population. Approximately 95% of sets are table models with 7-10 tube all-wave jobs preferred. Prices range from \$80 to \$120 cash or higher on installment plan. Current requirements are unique & should be studied before export.

ELECTRICAL AND RADIO WORLD TRADE NEWS—issued twice monthly, these detailed bulletins are well worth your study.

OFF THE PRESS

THE G-E MONOGRAM, General Electric Co., Schenectady, N. Y. 18 pp. This issue commemorates co.'s 61st Anniversary; interesting souvenir for those who can get it, but copies are tough to collar.

CATALOG NO. 86, Edwin B. Stimpson Co., Brooklyn, N. Y. 24 pp. Lists eyelets, grommets, etc., and machines for applying.

SERVICE EQUIPMENT ENCYCLOPEDIA, National Union Radio Corp., Newark, N. J. Lists mfr.'s tubes, condensers, panel lamps, etc., and catalogs leading service instruments of standard makes.

1939 RMS YEAR BOOK, Philco Radio & Television Corp., Philadelphia, Pa. 118 pp. Gives servicing data for mfr.'s home and auto sets, record changers, etc.; includes diagrams & all other necessary data. Sells at 75c.

TUBE BASE DATA, Connections and Charts, Issued by the Weston Electrical Instrument Corp., Newark, N. J. 4 pp. Covers over 500 different types of radio tubes.

CATALOG, The Turner Co., Cedar Rapids, Ia. 8 pp. Describes and illustrates microphones for commercial broadcast, amateur, recording and public address purposes. Features Model 44 X, a selective, directional, crystal mike.

CONDENSER MANUAL, Aerovox Corp., New Bedford, Mass. Complete information on replacement condensers in industrial motor-starting services. Included are diagrams, curves, formulas, specs., tables and self-calculating graphs of electrical characteristics. Makes job of replacement simple.

CATALOG, General Cement Mfg. Corp., Rockford, Ill. 20 pp. Illustrates and describes complete line of radio service cement, solvents, crystallizing lacquers, speaker accessories, bench-aid tools, recording lubricants, scratch repair kits, dial drives and the like.

FOLDER, Radio Mfrs. Service (Philco), Phila., Pa. 4 pp. Describes and illustrates new vibrator tester, signal generator, and circuit tester, plus several sales aids.

FOLDER, Hygrade Sylvania Corp., Emporium, Pa. 4 pp. Shows list prices of complete line of radio tubes, and tabulates list of interchangeable tubes. Also gives interesting analysis of tube-type sales.

RADIO FOTO LOG FOR 1940, National Union Radio Corp., Newark, N. J. 28 pp.; pictures, lists of European shortwave, U.S. broadcast, and telly stations. Offered to service dealers (with latter's imprinted name). Price 15c.

CATALOG, Cornell-Dubilier, S. Plainfield, N. J. 15 pp. Complete lists of replacement motor-starting capacitors; same Co. offers, gratis, 200 pp. condenser replacement manual with complete technical data, diagrams, etc.

CATALOG, Allen B. DuMont Labs., Inc., Passaic, N. J. 16 pp. Describes and illustrates the Du Mont Telly System, 1 kw. equipment, Nice job.

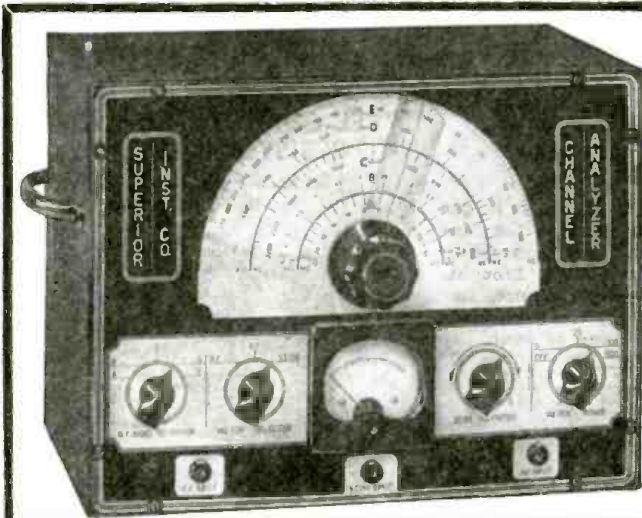

THE NEW CHANNEL-ANALYZER

FOLLOWS THE SIGNAL FROM ANTENNA TO SPEAKER OF ANY SET
The Well Established and Authentic

SIGNAL TRACING

method of locating the very circuit in which there is trouble, and the very component that causes the trouble, is now for the first time available at a price any radio serviceman can afford, and in an instrument that has been expertly designed and calibrated. The years of experience SUPERIOR has had in making fine test equipment are behind the CHANNEL-ANALYZER, the instrument that does what the usual test equipment cannot do, that raises servicing to a new high plane of speed and accuracy and marks the owner as one of the advanced operators in his field.

THE CHANNEL-ANALYZER WILL—

- Follow SIGNAL from antenna to speaker through all stages of any receiver ever made.
- Enable "LISTENING IN" to locate cause of distortion. The CHANNEL-ANALYZER has a jack for insertion of earphones so that you can listen to the signal directly from any stage and, therefore, discover the stage in which the distortion takes place.
- Instantly track down exact cause of intermittent operation.
- Measure both Automatic-Volume-Control and Automatic-Frequency-Control, voltages, and circuits without appreciably loading the circuit, using built-in

- highly sensitive Vacuum-Tube Voltmeter. The Vacuum-Tube Voltmeter may also be used as an independent instrument.
- Check exact gain of every individual stage in receiver.
- Track down and locate cause of distortion in R.F., I.F. and A.F. Amplifiers.
- Check exact operating voltages of each tube.
- Locate leaky condensers and all high resistance shorts, also show opens.
- Measure exact R.F., Osc. and I.F. frequencies, amount of drift and comparative output of oscillators in superhets.
- Track down exact cause of noise.

Fundamentally, what the Superior Channel-Analyzer does is to permit the serviceman to follow the SIGNAL from antenna to speaker through each and every stage of any set ever made, and inferentially, of any set that ever will be made, using the SIGNAL as the basis of measurements. Thus if there is trouble in one particular channel or stage of a receiver, the serviceman can isolate the faulty stage and then proceed to ascertain the very part or component that causes the trouble.

Many of the troubles in modern receivers are due to the Automatic-Volume-Control and Automatic-Frequency-Control circuits and ordinary instruments do not permit measurements directly upon these circuits, so the Superior Channel-Analyzer includes a direct-current Vacuum-Tube Voltmeter that DOES make these measurements directly and with a negligible loading of the measured circuits.

Other problems cease to be problems too, when the quick-solution method of the Channel-Analyzer is applied. For instance, suppose a local oscillator in a superheterodyne drifts. The Channel-Analyzer has a switch operated, tuned input circuit with amplifier, whereby not only the presence of drift may be discovered, but also the amount and direction of drift.

Distortion is another difficulty that often nettles a serviceman. The Channel-Analyzer has a jack for the insertion of earphones so that you can listen to the signal directly from any stage and, therefore, discover the stage in which the distortion takes place. Next, the VTM is used to discover the very component in that circuit that is causing the trouble. How often have you cherished the hope that someday you would own an instrument that enables you to measure the actual signal voltage across the load of any stage in the set, and thus by comparison determine the gain per stage. The Channel-Analyzer enables those dynamic voltage measurements and does a whole assortment of other work besides, yet

at a price much less than that usually asked for a dynamic voltmeter alone.

D.C. Voltages have important bearings on receiver performance. All these voltages can be measured on the Channel-Analyzer with the receiver in reproducing operation. In fact, that one important consideration, MEASUREMENTS WITHOUT MOLESTATION OF THE RECEIVER, gets rid of the drawback of most conventional equipment which greatly reduces the very voltage it attempts to measure, or kills the signal completely.

Tubes that are used in the receiver under test are also given a thorough check by the Channel-Analyzer and as such a specialized tube tester, this new and remarkable instrument is proof against any possibility of obsolescence.

Noise, another serious problem to servicemen, can be located with the aid of the Channel-Analyzer and can be done with incredible speed. Here are the basic components of the Channel-Analyzer:

1. B Supply rectifier and filter circuit.
2. One-stage, high-gain flat amplifier and linear diode detector.
3. Tuned-circuit, high-gain amplifier and linear diode detector, 100 KC to 18 MC.
4. D.C. Vacuum-Tube Voltmeter, for measuring the rectified R.F., I.F. or A.F., and for independent use on external circuits, all by front panel switching.

By adroit engineering and skillful application of a wide knowledge of servicing requirements based on Superior's years of experience, the four components listed above are made to do so many things and do them so well and fast that a large benefit is bestowed on servicemen, their tasks lightened, their work speeded and their experience greatly extended, all at record-breaking low price.

The Superior Channel-Analyzer comes housed in shielded cabinet and features an attractive etched aluminum panel. Supplied complete with tubes, three specially engineered shielded input cables, each identified as to its purpose. Also full operating instructions. Size 13"x10"x6". Shipping weight 19 pounds. Only

\$19⁷⁵

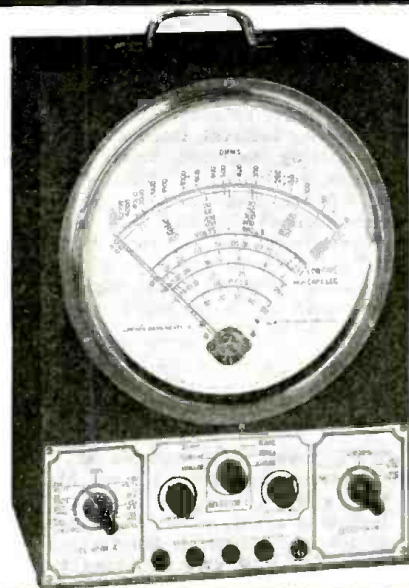

THE X-RAYOMETER FEATURES NEW GIANT 9" METER — AND A Built-in Power Supply Enables Resistance Measurements UP TO 30 MEGOHMS

SPECIFICATIONS:

RESISTANCE MEASUREMENTS IN 3 RANGES: 0-1000 Ohms, 0-100,000 Ohms, 0-30 Megohms.
D.C. VOLTAGE MEASUREMENTS IN 5 RANGES: 0-50, 0-250, 0-500, 0-1000, 0-2500 Volts. Television and other high voltage power supply circuits easily measured.
A.C. VOLTAGE MEASUREMENTS IN 4 RANGES: 0-50, 0-250, 0-500, 0-1000 Volts.
D.C. CURRENT MEASUREMENTS IN 6 RANGES: 0-1 Ma., 0-50 Ma., 0-250 Ma., 0-1 Ampere, 0-10 Amperes, 0-25 Amperes. High current ranges suitable for automotive and industrial work.
CAPACITY DIRECTLY READ ON METER SCALE IN 2 RANGES: .005 - 1 Mfd. 2 Mfd. - 50 Mfd.
X-RAYOMETER comes housed in a new army gray crystalline, heavy gauge cabinet. Complete with test leads, instructions and tabular data. Shipping weight 20 pounds. Only

PERCENTAGE OF LEAKAGE of electrolytics read DIRECTLY on meter scale. Actual condition of condenser quickly determined.
INSULATION INTER-ELEMENT and A.V.C. LEAKAGES directly read on meter scale up to 30 Megohms.
OUTPUT MEASUREMENTS IN 4 RANGES: 0-50, 0-250, 0-500, 0-1000 Volts. Built-in blocking condensers enable rapid alignment of radio equipment.
INDUCTANCE MEASUREMENTS IN 2 RANGES: 0 - 7 Henries, 7 - 703 Henries.
DECIBEL MEASUREMENTS IN 3 RANGES: D.B. based on 6 MW. at 500 Ohms. -10 to +20, -10 to +35, -10 to +40. Audio frequency measurements in both radio and P. A. amplifiers.

\$17⁹⁵

SUPERIOR INSTRUMENTS COMPANY
136 Liberty Street Dept. RC-2 New York, N. Y.

Please Say That You Saw It in RADIO-CRAFT

QUICKER, EASIER WAY
TO TRAIN FOR ELECTRICITY
12 Weeks Practical WORK IN MY CHICAGO SHOPS

WANT TO EARN MORE MONEY?

Don't be discouraged if you never had a chance to get much schooling. Don't think for a minute that you have to be a poorly paid, unskilled workman the rest of your life. You don't need a lot of book learning to have trained hands. Many of my most successful graduates never even finished Grammar School.



FIRST—You are told and shown how to do it.



THEN—You do the job yourself.

This same training is open to you—12 weeks of actual shop training in ELECTRICITY. Yes, shop training—real shop training. Instead of reading how to do things, you do them—right here in my Chicago Shops. You do real work on real generators, motors and dynamos. You do house wiring and wind armatures. You work in many other branches of electricity. And right now I'm including an extra 4 weeks Radio Course and valuable instruction in Diesel, Electric Refrigeration and Air Conditioning—all at no extra tuition cost.

AN EXTRA 4 WEEKS COURSE IN RADIO INCLUDED

I'LL FINANCE YOUR TRAINING

Don't let lack of money stop you! I have a plan that makes it easy for you to get this training, and you don't have to begin paying for the greater part of your tuition until 60 days after your 12 weeks training period is over. And then you have 12 months to complete your payments.

If you need a part-time job to help pay living expenses while you train, my employment department will assist you. After you graduate, this department will also give you lifetime employment service. Mail the coupon and I'll send you my big free book that's filled with interesting facts and shows dozens of pictures of students at work—doing the same things you will do. Fill in and mail the coupon today.

H. C. LEWIS, President

COYNE ELECTRICAL SCHOOL

500 South Paulina St. Chicago Illinois



HOUSE WIRING
 only one of the many branches you "Learn By Doing"



Coyne has first class instructors to teach you the simplest things to start with and they have the equipment to show you these things as you advance.
 Ben Rickman, S. Car.

MAIL THIS COUPON NOW

H. C. LEWIS, President
 COYNE ELECTRICAL SCHOOL
 500 S. Paulina St., Dept. 20-78, Chicago, Ill.
 Please send me free your big catalog and full particulars of your "Pay After Graduation Plan"—also other facts including offer of extra 4 weeks Radio Course at no extra tuition cost.

NAME.....
 ADDRESS.....
 CITY.....STATE.....

LATEST RADIO APPARATUS

NEW ELECTROLYTIC

Solar Mfg. Corp.
 Bayonne, N. J.

NEW construction design makes for longer trouble-free life. The base of the condenser is a novel soft-rubber molding through which all terminals are brought. Features are low contact resistance, improved R.F. characteristics, thorough sealing, and wet-electrolytic type of vent.

NEW T-PAD KONTAK MIKE

Amperite Company
 561 Broadway, New York, N. Y.



MODEL KKH includes hand volume control, is streamlined in design and smooth in action. As many as 4 units can be paralleled into one input. Volume control of one does not affect any of the others. Easy to attach to any string instrument such as violin, guitar, piano. Can also be used with harmonica or accordion. Works well with any standard amplifier.

AUTO-RADIO AERIALS

Philco Radio & Television Corp.
 Tioga & C Sts., Philadelphia, Pa.



TWO new types available. Standard 3-section cowl type and the super-de luxe "93" aerial. A newly-designed streamlined stanchion into which antennas are set gives the appearance of their being integral with the automobile. The mounting is made of a ceramic which is unaffected by moisture—assuring good reception in all weather conditions.

ELECTRIC SOLDER POTS

Lectrohm, Inc.
 5133 W. 25 Place, Cicero, Ill.

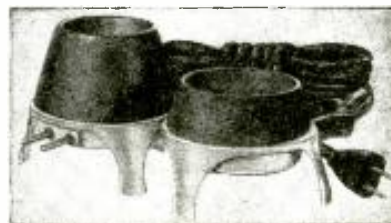

ELECTRICALLY-heated pots for tinning small electric wires and tube prongs. Each unit has a cast pot, of 1 3/4 or 2 lb. solder capacity, mounted on cadmium-plated steel stand. Its inexpensive nichrome element is easily replaceable. Operates on 115-V. outlet, A.C. or D.C.

"TEL-OHMIKE" CONDENSER-RESISTOR ANALYZER

Sprague Products Company
 North Adams, Mass.



NEW inexpensive instrument used in conjunction with the Serviceman's own milliammeter and voltmeter. The Tel-Ohmike permits capacity measurements from 10 mmf. to 2,000 mf., and resistance measurements from 0.5-ohm to 5 megohms. Has wide range of capacity and resistance, direct-reading scales and permits direct measurement of insulation resistance up to 10,000 megohms of such components as oil condensers under high voltage up to 1,000 V. Power factor up to 50 per cent may be read.

ELECTRIC TIME-DELAY SWITCH

The Partlow Corp.
 3 Campion Road, New Hartford, N. Y.

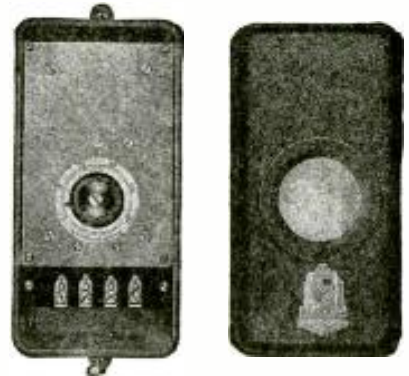

COMPRISES a synchronous timing motor driving a gear train through a magnetically-engaged clutch. The circuit is either made, or broken, at the end of the time-delay interval. Interval easily adjusted by setting external knob. Four timing ranges available, viz.: 0-5, 0-15, 0-50 min., or 0-5 hrs. The 0-5 min. model especially recommended for use with diathermy or shortwave therapy equipment inasmuch as its operation is entirely silent. *There is no clock ticking which might affect the nerves of an irritable patient.*

NEW VICTROLA

RCA Manufacturing Co.
 Camden, N. J.

THE model R-16 victrola is a compact instrument measuring 8 ins. high, 14 ins. wide and 9 3/4 ins. deep. Its many features include a silent, automatic, mercury on-off switch which controls the turntable motor, when the tone arm is moved toward the record, and vice versa; 3-point high-frequency tone control, automatic tone compensation, electrodynamic speaker; and a viscaloid-damped pickup. The instrument plays either 10- or 12-in. records.

Please Say That You Saw It in RADIO-CRAFT

"AUDIOGRAPH" 6 AND 115 V. AMPLIFIER

John Meck Industries
Randolph and Elizabeth Sts., Chicago, Ill.

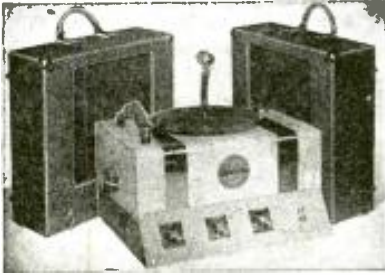

THE model AMR-25C amplifier provides 25 W. output and operates from either a 6 V. battery or 115 V. power line. Has inclined control panel, economy current-saving switch when operated by battery power, and optional phono player top with crystal pickup and constant-speed motor.

DE LUXE TUBE TESTER

Radio City Products Co., Inc.
88 Park Place, New York, N. Y.



THE model 311P is a counter tube tester which checks all tubes, old and new, as well as condensers, resistors, pilot lamps, miniature bulbs and ballast tubes. Tube readings are on a direct-reading scale. Instrument measures but 10 x 15 x 7 ins. high. The meter has a 4 3/4-in. scale fully calibrated on 4 multi-colored ranges.

PRONG-BASE MIDGET ELECTROLYTICS

Aerovox Corp.
New Bedford, Mass.

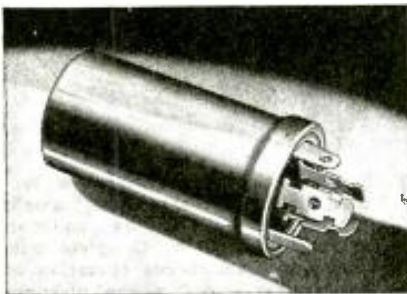

MIDGET can electrolytics with prong connections which slip into an elliptic supporting washer (fibre or metal) which is riveted or eyeletted to the chassis. Available in single and multiple section units and with insulated or grounded can.
(See following page for additional items)

*Enjoy Real Reception
with the new Meissner*

High-Fidelity

"CUSTOM 12"

Super-Quality Receiver



For Only
\$59.10 Net
Complete Kit

Twelve tubes — opening the way to a new world of living, breathing, pulsing power — tone quality too real to believe — power that is felt, as well as heard! This is truly a receiver of which any constructor may be justly proud — and one which any owner will never tire of showing off —

It was designed with one thought in mind — to produce a set having the finest quality audio system, coupled with a superior high-fidelity I.F. channel and a super-sensitive R.F. system. The last word in a high-grade receiver for home use! No compromise with cost has been made — specially designed components have been used where necessary — only the highest grade parts have been used throughout. The extent to which the desired result has been accomplished can only be judged by the critical listener.

The "Custom 12" provides complete coverage of the Long-wave, Broadcast and Short-wave frequencies in five bands from 132 to 42,000 kilocycles. High-gain "television" type tubes are used in the R.F. system and the I.F. channel provides variable band-width which may be expanded for high-fidelity reception. The audio system has a practically flat frequency response from 30 to 8000 cycles with a gradual drop to beyond the audible limit. Undistorted power output is conservatively rated at 15 watts.

Available in two models — one with cathode-ray Tuning Indicator — the other with the Meissner Push-Button Converter, easily adjusted for instantaneous push-button selection of seven broadcast stations.

All of these features are offered at a surprisingly moderate price. By assembling and wiring the receiver himself, the constructor is saved a large portion of the normal cost of such a receiver. All parts are furnished (except tubes and speaker) including the factory-wired, pre-aligned Tuning Unit which constitutes the entire "front-end" of the receiver.

Complete printed instructions are furnished with Schematic and Pictorial Wiring Diagrams — pliers, screw-driver and soldering iron are the only tools required. Anyone can build it in a few interesting hours!

Use the easy Meissner Time Payment Plan

The "Custom 12" and many other Meissner products may be painlessly purchased on a simple monthly payment basis. See your Jobber for details of this plan.

Write for Free Catalog

For further information on this remarkable receiver, as well as complete descriptions and prices on all Meissner products, write today for your free copy of the big 48-page complete catalog. Just cut off the lower portion of this ad, write your name and address on the page margin and mail to the address below.

DEPT. C-2

Hot off the Press!



A brand new 168-page book, full of live, interesting, up-to-the-minute radio constructional data and information. Contains complete diagrams and instructions for all the Meissner Kit Receivers as well as complete data on ready-wired units.

18-pages of latest Television data covering theory and practical application in plain language. See your Jobber at once or order your copy direct from factory. Only 50c net.



Please Say That You Saw It in RADIO-CRAFT

SYLVANIA HELPS TO HELP YOU SELL



Display This Electric Edgebrite Clock Sign

Made of sturdy, satin-finish metal, illuminated with two-lamp bulbs. Separate switch controls lights so clock operates at all times. Movement is self-starting. Convenient size, 13½" high, 20" wide . . . complete with YOUR NAME on illuminated glass panel \$6. Without name but with plain glass panel . . . \$5.



Put Up This Striking Flange Sign

Sign is weatherproof baked enamel on heavyweight sheet metal. Size, with detachable name plate, 16¼"x16". Without name plate, 16¼"x11¼". Flange Sign complete with YOUR NAME on name plate in baked enamel. . . . \$1.00 Sign, without name plate25c



New Electric Sign Can Increase Your Business

Strong metal frame electric sign trimmed in chrome plate with glass panel. Flat base for standing and adjustable chain for hanging. Size 22½" x 8¾" x 3¾". Complete with imprinted name plate \$2.25 Without name plate \$1.25

USE THIS VALUABLE COUPON
HYGRADE SYLVANIA CORPORATION
 Emporium, Pa.

Enclosed is.....Please ship the following:

- Electric Edgebrite Sign
- Metal flange sign, without nameplate
- Metal flange sign, with imprinted nameplate hanger.
- Electric Sign
- Imprinted nameplate, separate—Can be used either with flange sign or new electric sign.

Name

Address

CityState

Imprint

LATEST RADIO APPARATUS

(Continued from preceding page)

POWER WIRE STRIPPER

Ideal Commutator Dresser Co.
 3067 Park Ave., Sycamore, Ill.



A NEW low-cost power-driven brush-type wirestripper, known as model 9-C, strips wire insulated by cotton and enamel, silk and enamel, string asbestos and other light insulations from round, flat or rectangular, solid or stranded wire. Works well on "Litz" wires; ¼-h.p. motor drives the unit. Swell for light production work.

Works well on "Litz" wires; ¼-h.p. motor drives the unit. Swell for light production work.

NEW E.C.O. TRANSMITTER

Browning Laboratories, Inc.
 750 Main St., Winchester, Mass.



THIS instrument is an electron-coupled oscillator, all-band switch, exciter-transmitter, and voltage-regulated power supply, cooperatively sponsored by Amphinol, Cardwell, Cornell-Dubilier, Kenyon, Ohmite, ParMetal, and Raytheon. The instrument allows operation in any portion of any amateur band from 10 to 160 meters inclusive. Crystals may be used if desired. (Brochure and circuit diagram available.)

TINY METAL-CASED ELECTROLYTICS

Cornell-Dubilier Electric Corp.
 South Plainfield, N. J.

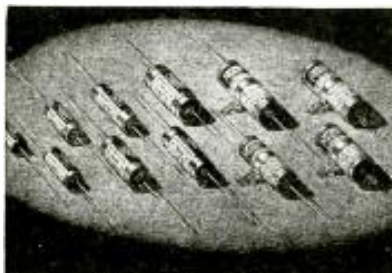

ONLY about 1/5th the size and weight of the older "can"-type electrolytic of equal capacity and voltage rating! Available up to 500 V. Cost less and therefore are ideal as replacements for receiver repairs. These units, known as the BR series, are available from 4 to 40 mf., and from 25 to 500 V. working.

COMMUNICATIONS RECEIVER

Howard Radio Co.
 1731 Belmont Ave., Chicago, Ill.

THIS new model 436 receiver is a 7-tube amateur and commercial communications instrument. Its frequency coverage is from 540 kc. to 43 mc. (550 to 7 meters). Also available to cover the range from 150 to 400 kc. (750 to 2,000 meters). Among its features are noise limiter, inertia knob, and new-type electrical band spread with scale over 8 ins. long.

1/2-IN. ELECTRIC DRILL

Independent Pneumatic Tool Co.
 600 W. Jackson Blvd., Chicago, Ill.



A HANDY tool for the Serviceman and auto-radio specialist. The tool weighs only 9¼ lbs. and has capacity up to ½-in. Its overall length is 15¼ ins. An extra-large air intake keeps the motor cool. Starting switch is in handle.

"DEFIANT" SX-24 SKYRIDER

The Hallicrafters
 2611 S. Indiana, Chicago, Ill.



HALLICRAFTERS' latest communication set features directly-calibrated band spread for the amateur ranges from 10 to 80 meters—this besides conventional band spread. Other features of the receiver include temperature-compensated tuning circuits, 4 selectivity positions, signal strength unit calibrated in "S" units and db., automatic noise limiter, continuous coverage from 540 kc. to 43.5 mc., crystal filter, B.F. oscillator, etc.; employs 9 tubes and operates from 115 V. A.C. Has provisions for operating from vibrator supplies as well.

COORDINATED SOUND SYSTEM

Radio Wire Television, Inc.
 100 Sixth Ave., New York, N. Y.



THE foundation of this system is the 7-tube model 452 "beam power" amplifier (illustrated here) with an undistorted power output of 30 W. Complete mixing facilities for simultaneous operation of 2 low-level mikes and 2 phono pickups or other high-level inputs. Gain is 130 db. and 80 db. from low- and high-level inputs, respectively. Coordinated accessories include two 12-in. dynamics with wall baffles, 100 ft. of rubber-covered cable, choice of 1 velocity or crystal microphone, microphone floor stand and all tubes, plugs and cables.

Please Say That You Saw It in RADIO-CRAFT

NEWEST GROUND CLAMP

Accessories Mfg. Co.
4612 N. Clark St., Chicago, Ill.

AFFORDS better contact with rods and tubes than older types—actually 8 sharp points of contact. Unit can be used for either high- or low-current voltage purposes. Made to fit any size rod, from 3/8- to 1-1/16 ins., or any size pipe from 1/4- to 3/4-ins.

LATEST "MYSTIC" MIKE

Olson Mfg. Co.
362 Wooster Ave., Akron, Ohio

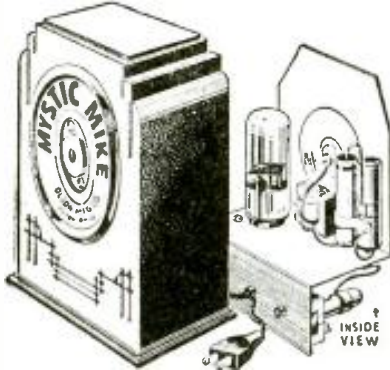

THE single bakelite cabinet houses both a sensitive microphone and the 1-tube oscillator - modulator circuit. No connection is required to the receiver. The instrument sends out a modulated radio signal to which any broadcast set may be tuned in the usual manner. Operates on 115 V., A.C.-D.C.

3-BAND RADIO WITH HI-Q SHORTWAVE LOOP

Majestic Radio & Television Corp.
2600 W. 50 St., Chicago, Ill.

THE chassis is a 9-tube console superhet. with 6 permeability-tuned pushbutton positions and 3 wavebands. Its main feature is the so-called "Rotoscope" (directional antenna) which is a rotatable loop for use on all bands. The loop has a Faraday static shield which, plus the fact that it is rotatable, permits it to cut through static with facility.

NEW CRYSTAL UNITS FOR AMATEURS

Hipower Crystal Co.
Chicago, Ill.

TWO series of crystals, known as "rubies" and "emerald" respectively. The smaller boast a temperature coefficient of 4 cycles or less per mc. per deg. Centigrade. The "emerald" are high-power units with a coefficient of 10 cycles or less per mc. per deg. Centigrade. These are available for the 160-, 80-, 40- and 20-meter amateur bands.

MIDGET SOLDERING IRON

Drake Electric Works, Inc.
3654 Lincoln Ave., Chicago, Ill.



THIS iron measures only 8 ins. overall, weighs 8 ozs., is rated at 60 W. and is fitted with 1/4-in. tip. The iron was especially designed for very light soldering and to meet the demand for an iron small enough to get into the smallest corners.

SOUND TIPS ABOUT THE SOUND THAT'S TOPS



NO MATTER how well a man looks in the pants and vest, he'll never be well dressed with a sleeveless jacket. Unless the suit is complete it's not very useful.

The same thing goes for commercial sound. The man who uses and recommends a complete line has a big jump on the fellow who doesn't. Because a complete line has the respect of a buyer. It tells him that there's reliability behind it. He buys

with confidence, secure in the knowledge that any time he wants to add to his original equipment he can do so without difficulty.

It will pay you to recommend RCA Commercial Sound because it's the only complete line in the business! A line built by the world's most experienced company in sound amplification. A line that means profits to you!



Any sound system sounds better, equipped with RCA Radio Tubes

A BIG SURPRISE IN STORE FOR YOU!

Be sure to read the announcement which appears on the inside front cover . . . DO IT NOW!

Examining **SOLAR**
EXAM-ETER
CIRCUIT and COMPONENTS ANALYZER
including PEAK VOLTMETER
A sensational! Combines more important test functions than ever offered before for only . . .
\$39.00 YOUR COST
Write for full details
SOLAR MFG. CORP. Bayonne, N. J.

BUYING GUIDE FOR HALF A MILLION RADIO MEN!
this Free catalog can save you plenty!
WRITE TODAY FOR FREE CATALOG NO. 78
LAFAYETTE RADIO
Dept. 3B—100 Sixth Ave., New York, N. Y.

Please Say That You Saw It in RADIO-CRAFT

NEWEST ELECTRONIC PIANO

(Continued from page 469)

if it's an RCP TEST INSTRUMENT you know it's a TOP VALUE!



In every RCP Test Instrument you get more and better ranges in addition to a quality, accuracy and appearance usually found only in much more costly equipment. So, if it's an RCP Test Instrument, you can be sure you're getting more test instrument VALUE for your money. Next time choose RCP—the line that outvalues them all!

CHECK THE "BONUS" FEATURES In this Dynoptimum Test Tube Checker

MODEL 308 BUILT BY RADIO CITY PRODUCTS



Fully equipped to test the NEW MINIATURE RECEIVING TUBES, as well as all ballast tubes and old tubes, all bantam, octal, loctal, all filaments or heaters up to full line voltage.

Tests under R.M.A. specified plate voltages. Hot interelement short and leakage tests between ALL INDIVIDUAL ELEMENTS. Hot cathode leakage test. Line voltage control, direct reading on meter. Spare socket for future tests. Provision for audible test of noisy tubes. Individual tests of each section of full wave rectifiers, duo diodes and all multi-purpose tubes. Adjustable for all line voltages 105-135 with line voltage indication directly on meter. And it's all quality! Here's a test instrument you'll be proud to use—proud of its appearance... proud of its performance... proud of the saving it represents. Dealer Net. **\$16.95**

Model 308P — Combination Portable Counter Model. **\$18.95**

MODEL 702 Better than ever and 30% less

Here's RCP Test Equipment with added new features, yet actually costing 30% less! Has all wave coverage from 95Kc to 100Mc. Output modulated at will. 30% modulation at 400 cycles, sine wave from self-contained independent 400 cycle circuit.



Attenuation in microvolts by means of five step ladder attenuator. Triple shielding. Double fused line. AC operated. Fine appearance. Dealer Net .. **\$22.95**



New FREE Catalog No. 121. Get the FEEL of these fine test instruments. Compare the features—and the values! Write for Catalog TODAY.

RADIO CITY PRODUCTS CO., INC. 88 PARK PLACE, N. Y. C.

wired to a terminal board. These 8 pickup plate assemblies are rigidly mounted at a fixed distance, adjacent to their respective strings.

Should feedback occur on any note, the Serviceman should check the phasing of the pickup units; or finally, try reversing the voice coil leads.

VOICING

For simplicity of construction and ease of assembly and service the pickup units are rigidly mounted in sections, as previously discussed, at definite spacing from their individual strings. Therefore, it is necessary to "voice" or equalize the output of the individual strings. This is done before the piano leaves the factory. But should it become necessary to replace a pickup unit in service the following procedure is given.

Voicing is accomplished by the following method which consists of *individually magnetizing the strings corresponding to each note* to an appropriate degree and polarity adjacent to the pickup, thereby either increasing or decreasing the pickup volume.

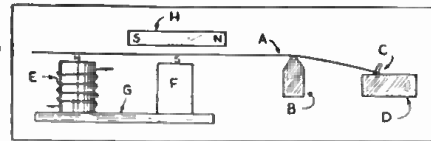

Fig. 2. "Voicing" is a new job for Servicemen.

Referring to Fig. 2 a single steel piano string is represented. The steel used for such strings is very readily magnetizable. This string shown at A, passes over the usual bridge B, and has one end attached to the hitch pin C, in the pin rail D, the other end being provided with appropriate tensioning means. Underneath the string is shown a magnetic pickup consisting of a coil E wound on the soft iron core and the permanent magnet F located on mounting plate G. The permanent magnet F induces magnetism in the core of coil E forming poles as indicated. When string A is sounded, a voltage is generated in pickup coil E.

The string A can be magnetized longitudinally by placing a bar magnet H having poles, S and N as indicated, spaced approximately the same distance as the spacing of the pickup coil E and the permanent magnet F, and moved along and substantially in contact with the string. The effectiveness of this magnetization on the pickup volume depends on how closely the poles of the magnet H approach those of the pickup unit. In other words, when the degree of magnetization in the string adjacent to the poles of the pickup is increased, as would be the case with the poles of the bar magnet H as shown, the current through the pickup coil will be materially increased for a given amplitude of vibration of the string.

If the poles of the magnet H are reversed

in position relative to the poles on the pickup unit and the string is thus magnetized then the amplitude of the current in the pickup coil will be decreased.

By following the above procedure the output from the weak notes may be increased and the output from the strong notes may be decreased producing the desired output over the entire scale for uniform force applied to each key.

In order to equalize the output of the various notes it is not necessary to use an output meter across a resistance load in place of the voice coil, for the use of the human ear is entirely satisfactory since it is in the end, the final criterion.

In order to check for grounds or opens in the pickup units, should a lack of volume be apparent while voicing, open pickup leads to amplifier, and between various pickup sections in turn, to localize the trouble.

AMPLIFIER

The A.F. amplifier consists of 2 major units. One is the amplifier proper, consisting of a 6J7 input stage, 6C5 driver, and four 2A3 output tubes in push-pull parallel; the other unit is the well-filtered power supply, using one 5Z3 tube as a rectifier.

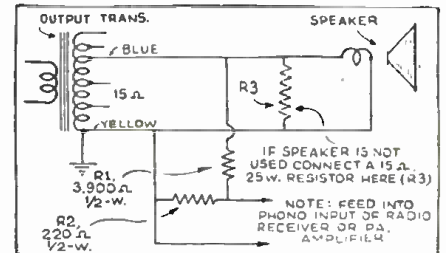
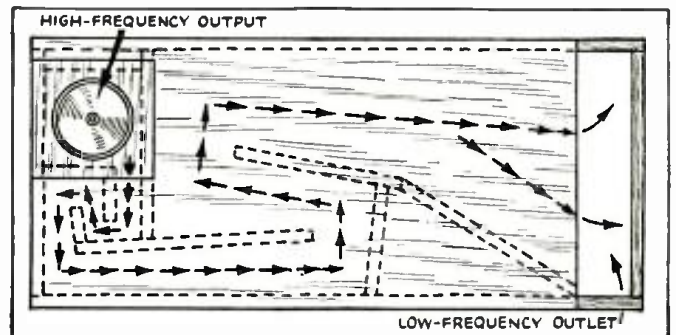

Fig. 3. Here's a recommended network for connecting the Storytone to an auxiliary amplifier.

The amplifier has 3 volume controls, one of which (R, in Fig. 1) is an integral part of the amplifier assembly. It is the *optimum volume control*, a screwdriver adjustment, and should be set at the desired level upon installation. It controls the maximum power output for the particular application and once set should require no adjustment. Its electrical function is to limit the amount of voltage applied to the grid of the input tube, which voltage has been induced in the pickup devices, thus controlling the maximum output of the amplifier.

The other 2 volume controls are not integral with the amplifier but instead are located for convenient operation by the artist. One, a *manual volume control* located at the left of the keyboard, is set for the desired volume output for the particular rendition. The other is a *pedal volume control*, operated by the left foot, its magnitude of control dependent upon the setting of the manual volume control at the left of the keyboard. The pedal control serves only to increase the volume from the level

The acoustical labyrinth shown at right may be compared with the photo at top of pg. 469. Middle and high frequencies are projected directly from the reproducer (in left side of piano); low frequencies are built up in the labyrinth (and reproduced from right side of piano).



Please Say That You Saw It in RADIO-CRAFT

set by the manual control to a maximum limited by the setting of the screwdriver control on the amplifier chassis.

The amplifier is provided with a *tone control* for operation in connection with external inputs and functions when such inputs are connected to the phonograph jack on the amplifier chassis.

HUM

Should hum occur which cannot be corrected by regular means in the amplifier or power supply, short-out the pickup coils at the input of the amplifier. If the hum disappears, then it is due to stray magnetic field. Check carefully the phasing of the pickup sections. If phasing is in accordance with wiring diagram, check to see that the power supply shield is properly placed and grounded. Check all ground connections and bonding of units between themselves and the frame of the piano.

Hum may be introduced by stray magnetic fields outside the instrument such as power transformers or electrical rotating machinery (motors or generators).

The socket voltages given on the schematic diagram are obtained at 115 V. on the 120 V. tap using a 20,000 ohms/volt meter (nearest scale D.C., and 1,000 ohms/volt A.C.).

USE WITH AUXILIARY EQUIPMENT

Should it be desired to connect the output of this instrument into an auxiliary amplifying system the method shown in Figure 3 should be employed. This consists of taking a small portion of the output voltage from across the voice coil, that obtained across resistor R 2, and applying it to the phonograph input of a radio receiver or P.A. amplifier.

NEW CIRCUITS IN MODERN RADIO RECEIVERS

(Continued from page 470)

(4) 1ST-DETECTOR USES GRID-TYPE DEMODULATION

Montgomery Ward Model 62-369 (Auto)—Fig. 4. Simplified circuit makes use of 6J7 oscillator-detector with a grid-leak-and-condenser detector action at the control-grid, and a cathode-type oscillator with plate feedback.

It will be observed that the gridleak and condenser values have quite a short time constant as compared to detectors for A.F. This is because the result of detection is to be the I.F. which is 175 kc. for this set. The 6J7 tube is better suited for detection of this type and since A.V.C. can be applied to other tubes this need not be a remote cut-off type. The plate-to-cathode feedback circuit is conventional.

(5) RECORD CUTTER PROVIDED ON NEW RECEIVER

Wilcox-Gay Model A-70—Fig. 5. A crystal cutter is used in this circuit which will record voice from an input microphone, radio reception or make duplicates of records.

The circuit with a level indicator is illustrated. Switch A may transfer from speaker to recording cutter without changing the transformer match to the output tubes. Switch B is provided to transfer the main impedance load to the cutter and yet maintain speaker operation while a record is being cut. Switch C is for turning the cutter on or off. A crystal cutter is used and an individual level indicator is provided for operation of the record cutter.

SCOTT
Custom Built Radio
SCOTT

PROVIDES NEARLY 3 TIMES THE TONAL REALISM THE AVERAGE LISTENER IS ACCUSTOMED TO HEARING

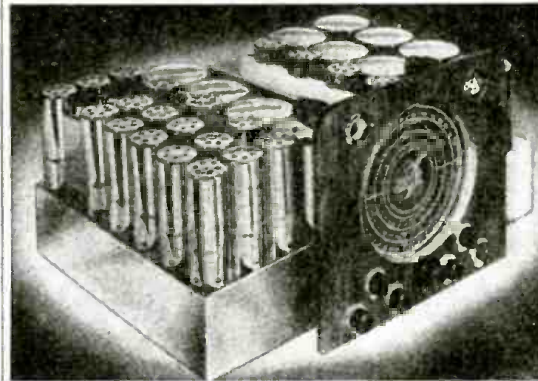

Above: Gleaming chromium plated Tuning Chassis of Scott Philharmonic, built with fine watch precision.

Below: New Scott Chipendale Cabinet, with special acoustical properties, for radio and record player.

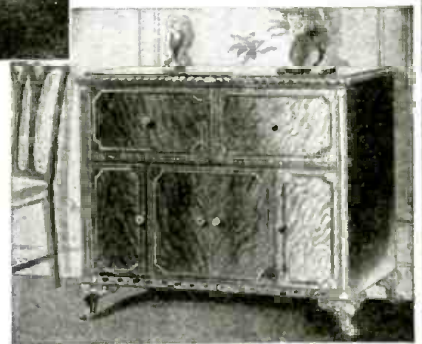

Whether it's a whispering violin or the vibrant crashing of a hundred brasses . . . a SCOTT captures every tone, from the lowest to the highest. Whether it's radio or recorded music, EVERY INSTRUMENT is reproduced with such amazing realism the artists seem to be in the room with you! Don't take our word for it. Hear the SCOTT yourself . . . you be the judge. Test a Custom Built Scott in your own home for 30 days!

THE "WORLD'S FINEST RADIO"

Your SCOTT will be Custom Built, to order, for performance (broadcast, short wave, or recorded music) impossible with factory production type equipment. It will cost little more than many other radios, for the SCOTT is sold ONLY direct from our Laboratories. No jobber and dealer mark-ups. The design is far advanced. Many technical features are amazing SCOTT developments used only in our receivers. Small wonder world famous musicians, scientists, diplomats, as well as leaders in society, industry and thousands of critical listeners in the U.S. and 154 foreign countries, have chosen the SCOTT for their personal use.

GUARANTEED 5 YEARS • 30 DAYS HOME TRIAL

Your SCOTT will be guaranteed 20 times longer than the usual 90 days adopted as standard by the radio industry. Budget terms if desired. Deliveries in 3 to 4 weeks still being maintained, although demand has increased tremendously!

A FEW OF MANY AMAZING FEATURES

- 6 noise reducing systems • 6 wave bands from 3.75 to 2000 meters including ultra high frequencies • overall fidelity 30 to 16,000 cycles • 40-60 watts undistorted Class A power output • Continuously variable selectivity from 2 to 16 KC., Sensitivity from 5m. to 20m. • Record scratch suppressor and many others.

MAIL THE COUPON TODAY! . . . GET SPECIAL LIMITED OFFER!



E. H. SCOTT RADIO LABORATORIES, INC.

4404 RAVENSWOOD AVENUE Dent. 24840 CHICAGO, ILLINOIS
Send special offer, order blank, and all facts on new Scott Philharmonic, Phantom De Luxe, and Masterpiece models. Also send Scott Record Review. No obligation.

Name

Street

City State

STUDIOS: NEW YORK BUFFALO DETROIT CHICAGO LOS ANGELES

A NEW BOOK ON PUBLIC ADDRESS

An important announcement about the greatest book on the subject of sound and allied subjects appears on Page 510 of this issue. **TURN TO THE ANNOUNCEMENT NOW!**

IF IT'S RADIO

ALL YOUR RADIO NEEDS

Here in this one big book you will find everything you need in radio . . . sets, parts and supplies . . . public address systems . . . amateur equipment . . . testers and kits . . . your nationally known favorites at lowest possible prices. Write today for this big valuable catalog and save money.

FREE CATALOG

PROMPT SERVICE

BURSTEIN-APPLEBEE COMPANY

1012-14 McGEE STREET, KANSAS CITY, MISSOURI

Now!

BALLAST REPLACEMENT

made **AMAZINGLY SIMPLE!**

Only 4 standard types of Ameriprite AC-DC Regulators will replace 90% (over 100 types) of AC-DC Ballast Tubes now in use!

WRITE FOR CHART AR.

New Low Price \$1.00 List

AMPERITE 361 BROADWAY, N. Y.

AMPERITE AUTOMATIC REGULATORS

Please Say That You Saw It in RADIO-CRAFT

2-IN-1 "CARD FILE" BATTERY SET

(Continued from page 464)

Revolutionary P.A.

COMPLETE!
BUILT-IN PHONO
NOTHING TO ADD

FILLS 75% OF ALL P.A. REQUIREMENTS

PLAYS ON E 32 or 110 VOLTS A.C. or D.C.

The Knight Universal 20-watt—America's only truly Universal Sound System—plays anywhere, any time, from any voltage source, with superb output, and amazing tone fidelity. Look over this list of features:

Full 20 Watts Output
Gain: Min. 135 db.
Gain: Max. 80 db.
Automatic Selection
Four Input Channels
Dual Tone Inverse Feed.
With Remote Control

Speaker Selector Switch With Stand By Switch
Jensen P. M. Speakers
Silencer Mike Input
V. I. Meter and Monitor
E. R. P. I. Licensed

Priced amazingly low, available on easy terms. See new system (and 75 watts) in ALLIED's 1940 catalog—SEND COUPON.

FREE CATALOG

ALLIED RADIO

ALLIED Radio Corporation
833 W. Jackson Blvd.,
Dept. 2-AB-O,
Chicago, Illinois

Hush your FREE 204-page Catalog of P.A. Systems and complete radio supplies.

Name

Address

City State

Westinghouse Power Generator

Manufactured for U. S. Signal Corps
200 Watt. 110 V. AC

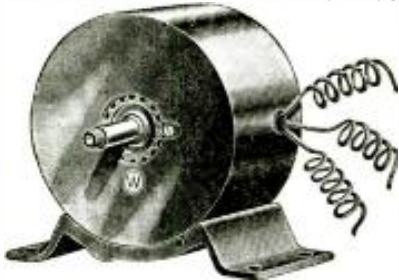

A. C. ELECTRICAL POWER

from a Windmill, from available Waterpower, from your Automobile, from your Motorcycle, from your Bicycle. Foot-pedal or Handcrank (for transportable Radio Transmitters, Strong Floodlights, Advertising Signs); do you want to operate AC Radio sets from 32 V. DC farm light systems; operate two generators in series to get 200 V. AC; obtain two phase and three phase AC, etc., etc.

There Are Over 25 Applications
Some of which are:

A.C. Dynamo lighting from eight to ten 20 Watt 110 Volt lamps. Short Wave Transmitter supplying 110 Volts AC for operating "Ham" transmitter. Operating 110 V. Radio Receiver in DC districts. Motor Generator, Public Address Systems, Electric Signs on motor boats, yachts, etc. Camp Lighting. Short Wave artificial "fever" apparatus. Television, Pelton Waterwheel for lighting or other purposes. Airplane: for lighting strong searchlights or electric signs. Laboratory work, etc. $\frac{1}{4}$ to $\frac{1}{2}$ H.P. needed to run generator.

BLUE-PRINT 22 x 28 in. and Four-Page
 $8\frac{1}{2}$ x 12 in. INSTRUCTION SHEETS
FREE with Generator.

Generator, as described, including Blue-print and instructions. **\$7.90**
Send \$2.00 deposit, balance C.O.D.
Shipping weight 18 lbs.

MONEY-BACK GUARANTEE

WELLWORTH TRADING COMPANY
1915 S. State Street, Dept. RC-240, Chicago, Ill.

quire the same space as the Raytheon RK43 or standard 1D8GT, so the midget tubes were not used because of mechanical complications as to sockets and mounting.

The variable condenser is a revamped Cardwell midget of 15 plates, in which the capacity of 100 mmf. has been increased to approximately 300 mmf. by the use of mica or celluloid dielectric rather than air. The resistance thus introduced into the secondary or grid circuit is naturally compensated for by the feedback from the plate circuit. The revamping is described in a later paragraph.

The chassis itself is only a simple bracket which is fastened to the bakelite panel by the mounting bushing of the tuning condenser. A metal panel may be used and in some instances may be of advantage if there is body capacity.

The audio transformer is a standard $3\frac{1}{2}$ to 1 (ratio) midget. The regeneration control may be any of the 1-in. diameter midget type so long as a satisfactory value and taper are used. These are not in the least critical.

The Yaxley 2-W, 1-in. diameter 15-ohm rheostat serves the triple purpose of filament switch, a means of conserving "A" battery life, and as a vernier control for regeneration.

The fixed condensers are of the postage-stamp size. The special coil which has a tap for the amateur phone—police band is miniature in size, the construction being described in a later paragraph. It is mounted on the frame of the A.F. transformer by simply soldering its mounting bracket thereto.

The "B" battery is an assembly of 8 fountain-pen flashlight cells into a flat, compact unit, as is described in a later paragraph. The life of this unit will be considerable as the drain, by the plates of the dual-element tube, will not exceed 4 milliamperes at the voltage used.

The writer naturally appreciates that many constructors will use parts already on hand and therefore has allowed a great deal of latitude in the selection of components other than those specified. It must be remembered however that every inch counts towards the ultimate size of the receiver.

MAKING THE COILS

As shown in illustration A, the secondary consists of 3 pies of 65 turns, each of No. 10/41 Litz wire on $\frac{3}{8}$ -in. I.D. tubing into which is inserted a polyiron core of $\frac{3}{8}$ -in. dia. by 1-in. long. Each pie is $3/16$ -in. long. The coils are wound lateral, with approximately $3/32$ -in. spacing between pies. The first pie of 65 turns is used for the S.-W. police band. The mutual conductance between pies may be varied to match the inductance to the special variable condenser by increasing or decreasing the spacing between pies.

The primary or tickler winding consists of approximately 260 turns of No. 36 double silk (D.S.C.) or single-cotton covered S.C.C. wire, wound laterally and at the grid end of the secondary. The $\frac{3}{8}$ -in. inside diameter plus wall of the tubing is used for the secondary; length or width of winding is $3/16$ -in.

If the constructor does not desire to lateral-wind the coils they may be slot-wound on a form which may then be knocked down and the coils doped. In this manner when coils are in pies the distributed capacity is very little more than lateral windings. With correct modification of the condenser (a Cardwell 15-plate mid-

get) the distributed capacity of the coils should be low enough to tune from 1,500 to 570 kc.; that is, when spacing between pies is correct (variometer fashion of tuning).

To modify the Cardwell condenser, the plates are disassembled from the rotor shaft, and the stator plates from the isolantite end insulation plate; 14 pieces of celluloid (used in side curtains of open cars) are cut to the pattern. The large center hole should clear (freely) the rotor spacing washers. The smaller holes should freely clear the stator plate spacing washers. See illustration B.

The condenser plates are now reassembled, first a stator plate, then spacing washers, then celluloid spacer, then rotor plate, then celluloid spacer, then rotor plate spacer washer, then another stator plate, and so on, until all are assembled. Clamp the rotor shaft in a vise, line up the rotor plates, and tighten the nut. Use a lock-washer under the nut as the rotor assembly must be tight enough to withstand the drag or friction of the plates against the celluloid spacers. If celluloid is not available, mica of equal thickness may be used. Both have a dielectric factor of from 3 to 4 as compared to air. The celluloid spacers should occupy nearly all of the air space between the plates.

Note: If polyiron cores are not used for the coils, approximately 4 pies of 65 turns will be required with a corresponding increase in the number of tickler turns.

The 12-V. "B" battery is assembled by connecting 8 fountain-pen flashlight cells in series. Solder each positive terminal (center tap) to the zinc shell of each succeeding cell as shown at C.

After the cells have been soldered together each cell is insulated where a possible short might occur; and then made into a flat package approximately 2 ins. wide, 4 ins. long and $\frac{5}{8}$ -in. thick, using scotch or gummed tape.

Note: Cabinet or container is standard size and was purchased from a Woolworth store for 25c. A metal partition is soldered in position if space for phones is desired. Otherwise the space may be used for additional "B" batteries, and the panel extended to the back of the cabinet.

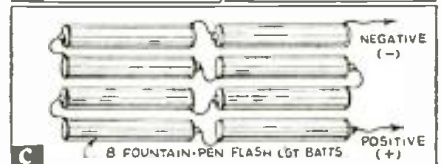
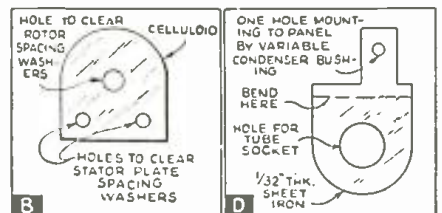
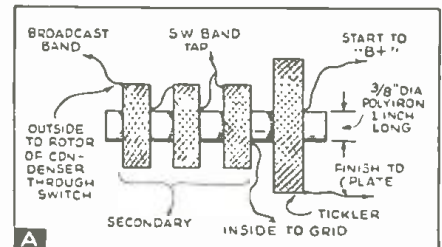

Please Say That You Saw It in RADIO-CRAFT

NOTES

(A) The receiver has been designed for a very small antenna such as a large window or door flyscreen, bed spring, or approximately 25 ft. of wire.

Should a larger antenna of greater capacity be employed, a mica compression condenser should be placed in series with the antenna lead of the set.

(B) Under certain conditions of operation, the A.F. tube may oscillate due to a low "B" battery; the writer suggests reversing the secondary leads of the A.F. transformer.

(C) For smooth regeneration a larger or smaller grid leak may be necessary.

(D) The tube socket bracket is one hole mounting made if desired from one piece of metal shaped as shown at D.

THE RADIO MONTH IN REVIEW

(Continued from page 455)

Calif.; "May" is out to acquire an F.M. channel while the acquiring is good. A 1-kw. station, on 43 mc., has been requested for a spot at Wilshire Blvd., at Fairfax Ave. Good luck on your F.M. request, even though your television application (Sept. 1939 *Radio-Craft*, pg. 134.) is still "under consideration" . . .

Onondaga Radio Broadcasting Corp., Syracuse, N. Y.; has an application in for an F.M. xmitter on 43 mc., 1 kw. . . . Columbia Broadcasting System, Inc., New York, N. Y.; come on in, C.B.S., the water's fine! Maybe you'll get that 50-kw. F.M. station in the Chrysler Bldg. onto the air yet, on 43 mc. . . .

Westinghouse Electric & Mfg. Co., Phila., Pa.; application is for an xmitter on 42.6 mc., 1 kw., in Architects Bldg., Phila. . . . Midland Broadcasting Co., Inc., Kansas City, Mo.; application for an F.M. station on 42.6 mc., 1 kw., was returned. . . . WBNS, Inc., Columbus, Ohio; yippee!, granted OK to put up a 250-watt station on 43 mc. . . . Columbia Broadcasting System, Inc., Minneapolis, Minn.; wants to switch W9XHW to new site at Boston, Worcester, or adjacent point in Mass., and to increase power to 1 kw. on 42.3 to 42.8 mc. . . . Another Columbia Broadcasting System application would have W2XDV moved to the Chrysler Bldg., and there push out F.M. programs with 1 kw. on 43 mc.

Pennsylvania Broadcasting Co., Phila., Pa.; requested an OK to go on the air with 1 kw. on 43.4 mc., at 35 S. and 9th Sts., same city. . . . Miami Broadcasting Corp., Dayton, Ohio; their bid is for a 1 kw. F.M. job on 42.6 mc., near Dayton . . . RCA Mfg. Co., Camden, N. J.; requested permission to continue, for another month, experiments in F.M. operation with 1 kw. on 42.6 mc., over W3XEZ. . . . Yankee Network, Inc., Boston, Mass.; permission was given to continue tests of W1XOJ on 43 mc., 2 kw. . . . Westinghouse Elec. & Mfg. Co., Allison Park, Pa.; a request is in for a 1 kw. station on 42.6 mc. at Clearview Road on Route 8, Allison Park, Pa. This is an F.M. freq.

(Continued on page 504)

Here's How---

-- a Radio SHOULD BE Tested -- at a PROFIT!
One Probe!
DOES IT ALL!



Instead of several cables to confuse the operator, the Audolyzer uses one cable with which over 75% of all work is performed. This probe is of such unique design that it can be used in making tests on any part of the receiver without affecting the receiver's operation. (Two other inputs are provided when the occasion demands two or more tests to be made simultaneously.) The one common probe is rapidly switched from circuit to circuit and has the following functions:

R. F. IN: The probe feeds a two stage amplifier tuned over the ranges of 95 K.C. to 14.5 M.C. in five bands. Its sensitivity is great enough to monitor signals in the first R.F. stage. With the aid of the Audolyzer's R.F. multiplier and attenuator its sensitivity can be reduced and used to monitor the strongest R.F. signal found on the second detector plate or the oscillator grid. The meter is used with the R. F. amplifier to compare signal strengths. For simple signal tracing through the R.F. stages, the speaker gives a quick audible check.

at the first audio grid, the signal is followed to the speaker's voice coil, the Audolyzer's speaker being used as a monitor.

A. F. OUT: When the "Probe Selector" is set in this position, the Audolyzer is set up as a receiver. When a station is tuned in, the audio signal is present at the tip of the probe for the quick checking of P.A. amplifier and receiver audio systems.



A. F. IN: When the signal has been traced to the second detector plate, simply set the "Probe Selector" to the "A.F. IN" position and finish the tracing job with the same probe. Starting

V. M.: Should any signal tracing step indicate trouble, a quick D. C. voltage check can be made at any point by setting the "Probe Selector" to the V. M. position. With this set-up, A.V.C., GRID BIAS, SCREEN, PLATE and POWER SUPPLY voltages can be measured without affecting the receiver operation.

Why hasn't this been thought of and developed before? To test a radio, what is more simple or logical than to substitute a stage or part that is known to be good for the defective stage or part, while the receiver is in operation. Use only one probe—just listen for the trouble . . . that's AUDOLYZING.

SUPREME INSTRUMENTS CORP. **SUPREME** EXPORT DEPT. Associated Exporters Co., 145 W. 45th Street, New York Cable Address: LOPREH, N. Y. GREENWOOD, MISSISSIPPI, U. S. A.

GET A REAL ELECTRIC DRY SHAVES ABSOLUTELY FREE!
Complete details as to how it is possible to get a Real Electric Dry Shaver FREE, appear on Page 504 of this issue. **TURN TO IT NOW!**

IN MARCH RADIO-CRAFT!
Marine Radio Telephone Installation and Servicing
How to Make a 2-Tube Plug-in Coil Breadboard Receiver
The "New" KDKA
Public Address in an "Oceanarium"

8-TUBE, 2-BAND SUPER AC-DC
each in lots of \$11.23
\$24.95 list model 373 GOLDENTONE. Check these 1940 features: Dynamic speaker, Walnut cabinet, Illuminated vernier tuning dial, "Goldenscope" no aerial or ground required. Receiver, Coast to Coast, on Broadcast and Police, Amateur, Aeroplane, etc., on Short Waves. One year guarantee. Send \$1.00 deposit, balance C.O.D. Money back if not satisfied.
GOLDENTONE RADIO CO. Dept. RC DEARBORN, MICH.

RADIOS SAVE UP TO 50%
DEAL DIRECT-FAC TORY PRICES! Many models to choose from at wholesale prices. AC-DC midsets \$1.98 Part. sets and battery sets \$8.98 up. Car sets \$11.75 up. Also complete, all-wave, etc. samples at 25¢ off. Send for FREE 1940 catalog giving details of 15 day FREE trial and accessories and accessories proposition and discounts. No obligation, write today.
GOLDENTONE RADIO CO., DEPT. RC, DEARBORN, MICH.

Please Say That You Saw It in RADIO-CRAFT

Big Value... TUBE TESTER COMBINATION

ONLY
\$26.85
DEALER
NET



With
RED•DOT
Lifetime
Guaranteed
Meter



MODEL
432-A-742

- Model 432-A-742 is a combination Tube Tester and Volt-Ohm-Milliammeter.
- Complete Volt-Ohm-Milliammeter, 16 Ranges • Sockets for All Tubes... Filament Voltages from 1 to 110—A Safeguard Against Obsolescence • Precision Indicating Instrument with Two Highest Quality Sapphire Jewel Bearings • Separate Line Control Meter • Neon Shorts Test • Approved RMA Circuit • Portable Rich Black Leatherette Covered Case — Professional in Appearance, Etched Panel. Complete, less batteries... \$26.85... Dealer Net Price.

WRITE FOR CATALOG! Section 216 College Avenue
READRITE METER WORKS, Bluffton, Ohio

New TURNER Dynamic

Model 22D-Protected for Ham; Handles Toughest P. A. Jobs

For exceptional performance, you can't tie 22D at such an attractive low price. 10° tilting head, removable cable set, and full satin chrome finish. Advanced engineering style. Cuts thru QRS and reproduces smoothly at all frequencies. Works equally well indoors or out, and its low feedback is amazing. Packed with charcoal-mike base, and wiring diagrams. Hi-impedance with 7 ft. Cable Set. List \$20.00. Add \$1.50 for 25' Cable Set. Deduct \$1.50 for 50 ohm model. Send for Free Catalog.

MODEL 22D
Level—54DB
Range 40-8000
cycles.

The TURNER CO.
907 Seventeenth St., NE
CEDAR RAPIDS, IOWA

1/20 H.P. UNIVERSAL G.E. MOTOR 6 VOLT D.C.

Specifications: 1/30 H.P. Heavy Duty operates on either A.C. or D.C., 110 volts, 3200 R.P.M., with 1/2" cord and plug. Rheostat can be used to vary speed. Height 3 3/4", Length 3 3/4", Width 3". Shaft 3/8". Can be used to drive Sewing Machines, Models, Buffing Lathes, Polishing Head, Drills, Grindstones, etc., same type motor furnished in 6 volt D.C. Less cord and plug \$1.95.

MOTOR Universal 1/30 H.P. \$2.55
MOTOR 6 Volt D.C. \$1.95

Shipping weight, either style 3 lbs. Money back guarantee. Send check or M.O. Add 25c for special packing and mailing anywhere in U. S. A.

WELLWORTH TRADING COMPANY
1915 SO. STATE ST., Dept. RC-240, Chicago, Ill.

Correspondence Courses in
RADIO and ELECTRICAL ENGINEERING

ELECTRICAL ENGINEERING Get good grasp of wide electric field. Prepare yourself, at Low Cost, for secure future. Modern, simplified, you can understand quickly.

RADIO ENGINEERING Extra fine course in radio, sub-titles: the address, photo-electric work. Trains you to be super-service man, real vacuum tube technician. Exper. kits furnished. Diploma on completion. Tuition, \$25. either course. Deferred payment plan. Get copies of school catalogs, student magazines, complete details. SEND NOW!

FREE

LINCOLN ENGINEERING SCHOOL, Box 931-C14, LINCOLN, NEBR.

RADICALLY NEW MINIATURE TUBES

(Continued from page 465)

word! That is, there is no removable base of metal or plastic. The "base" has now become part of the bulb—it is a glass plate that closes-off the bottom of the glass envelope—and thus the base as a separate item HAS CEASED TO EXIST!

Tentative characteristics data on these 4 new tubes are available. So, too, are symbols which we here reproduce. The proportionate dimensions of a representative tube also are shown.

DETAILS

In checking over the symbols of these tubes it will be observed that in some cases the connections are duplicated on other terminals. This is because the leads are used as mountings and sometimes there are 2 mountings, and hence 2 leads, per element. This explains why, in the 1R5 and 1T4, terminals 1 and 5 both connect to the filament. In the 1S4 not only does one lead of the filament have 2 prongs, terminals 1 and 5, but also the plate has 2 mountings, and therefore 2 prongs, or terminals, 2 and 6. These extra prongs in addition to affording extra strength also serve as additional tie points when making connections.

Not shown in symbolic form in the connections of the 1T4 is the internal shield which connects to terminals 1 and 5. This shield is a little metallic button inside the bulb near the bottom and within the inside circumference of the prong-leads.

The use of shielding in the 1T4 to reduce interelectrode coupling at the prongs is carried a step further in the new sockets which have been developed for the miniature tubes. These sockets are provided in the center with a hollow metal tube which extends further than the length of the prongs. This hollow-center pin may be made to float or to connect to terminal 1.

The diode in the 1S5 is located over a mica plate below which is the remaining pentode assembly.

Tentative Characteristics Data

1R5—Pentagrid Converter

Filament voltage (D.C.)	1.4 volts
Filament current	0.05 ampere
Direct interelectrode capacities:#	
$C_{k_2} (f + g_1 + g_2 + g_3 + g_4 + g_5 + p)$ = R.F. input	7.0 mmf.
$C_p (f + g_1 + g_2 + g_3 + g_4 + g_5)$ = mixer output	7.0 mmf.
$C_{g_1} (f + g_2 + g_3 + g_4 + g_5 + p)$	3.8 mmf.
$C_{g_2 p}$	0.4 max. mmf.
$C_{k_1 g_3}$	0.2 max. mmf.
$C_{k_1 p}$	0.1 max. mmf.

#With no external shield.

Converter Service

Plate voltage	90 max. volts
Screen-grid (Nos. 2 & 4) voltage	45 max. volts
Screen-grid supply voltage	90 max. volts
Plate dissipation	0.09 max. watt
Screen-grid dissipation	0.115 max. watt
Total cathode current	3.6 max. ma.
Control-grid (grid No. 3) voltage	0 min. volts

Typical operation:

Plate voltage	45	90	volts
Grids Nos. 2 & 4 voltage	45	45	volts
Grid No. 3 voltage*	0	0	volts
Grid No. 1 resistor	0.1	0.1	megohm
Plate resistance (approx.)	0.6	0.75	megohm
Conversion transconductance	235	250	micromhos
Grid No. 3 bias (approx.) for convers. trans. cond. = 5 micromhos	-9	-9	volts
Plate current	0.7	0.8	ma.
Grids Nos. 2 & 4 current	1.9	1.8	ma.
Grid No. 1 current	0.15	0.15	ma.
Total cathode current	2.75	2.75	ma.

*Referred to negative filament terminal.

Note: The transconductance between grid No. 1 and grids Nos. 2 & 4 tied to plate (not oscillating) is approx. 1,200 micromhos when grids Nos. 1 & 3 are at zero volts, and grids Nos. 2 & 4 and plate are at 45 volts.

lating) is approx. 1,200 micromhos when grids Nos. 1 & 3 are at zero volts, and grids Nos. 2 & 4 and plate are at 45 volts.

1S4—Power Amplifier Pentode	
Filament voltage (D.C.)	1.4 volts
Filament current	0.1 ampere

Amplifier—Class A ₁	
Plate voltage	45 max. volts
Screen-grid voltage	45 max. volts
Plate dissipation	0.18 max. watt
Screen-grid dissipation	0.05 max. watt

Typical Operation and Characteristics:

Plate voltage	45	volts
Screen-grid voltage	45	volts
Control-grid voltage*	-4.5	volts
Peak A.F. grid voltage	4.5	volts
Zero-signal plate current	3.8	ma.
Zero-signal screen current	0.8	ma.
Plate resistance (approx.)	0.25	megohm
Transconductance	1,250	micromhos
Load resistance	8,000	ohms
Total harmonic distortion	12	per cent
Max.-signal power output	0.065	watt

1S5—Diode-Pentode	
Filament voltage (D.C.)	1.4 volts
Filament current	0.05 ampere

Characteristics of Pentode Unit		
Plate voltage	45	volts
Screen-grid voltage	45	volts
Control-grid voltage	0	volts
Plate resistance	0.5 approx.	megohm
Transconductance	525	micromhos
Plate current	1.2	ma.
Screen-grid current	0.3	ma.

Pentode Unit—Class A ₁ Amplifier		
Plate voltage	90	max. volts
Screen-grid voltage	90	max. volts
Plate dissipation	0.06	max. watt
Screen-grid dissipation	0.025	max. watt

Typical Operation as Resistance-Coupled Amplifier:		
Plate-supply voltage	41	volts
Screen-grid supply voltage	41	volts
Control-grid voltage*	0	volts
Plate-load resistor	1	megohm
Series screen-grid resistor	3	megohms
Screen-grid by-pass condenser	0.1	mf.
Control-grid resistor	10	megohms
Voltage gain (approx.)#	30	

*Referred to negative filament terminal.
#Obtained when the grid of the pentode unit is fed from a source having an impedance of 1 megohm.

Diode Unit
The diode is located at the negative end of the filament, and is independent of the pentode unit except for the common filament.

1T4—Super-Control R.F. Amplifier Pentode Amplifier—Class A₁

Plate voltage	90	max. volts
Screen-grid voltage	45	max. volts
Plate dissipation	0.2	max. watt
Screen-grid dissipation	0.035	max. watt
Control-grid voltage	0	min. volts

Typical Operation and Characteristics:

Plate voltage	45	90	volts
Screen-grid voltage	45	45	volts
Control-grid voltage*	0	0	volt
Plate resistance	0.25	0.8	megohm
Transconductance	700	750	micromhos
Transconductance at -10 volts bias	10	10	micromhos
Plate current	1.9	2	ma.
Screen-grid current	0.7	0.65	ma.

Filament voltage (D.C.)	1.04	volts
Filament current	0.05	ampere

Direct Interelectrode Capacities:#	
Grid to plate [C _{g,p}]	0.01 max. mmf.
Input [C _g (f+g ₁)]	3.5 mmf.
Output [C _p (f+g ₁)]	7.3 mmf.

#With no external shield.

FOOTNOTES—(See Pg. 465.)
(1) See the "Special Metal Tube Number" of Radio-Craft, October 1935.
(2) "Recent Radio Tubes," Radio-Craft, May 1938.
(3) "15 New Tubes," Radio-Craft, Nov. 1938.
(4) "New Tubes for 1939," Radio-Craft, Dec. 1938.
(5) "9 New Tubes," Radio-Craft, Sept. 1939.
(6) "48 New Tubes," Radio-Craft, May 1939.

Please Say That You Saw It in RADIO-CRAFT

SERVICING PUZZLERS

(Continued from page 471)

● **Distortion on Strong Signal.** A 1932 Majestic Model 320 receiver had a badly distorted tone when any but a very weak signal input was applied to the antenna. A check of the tonal qualities of the audio end showed it to be OK. Acceptable tone quality on a weak signal indicated the A.V.C. circuit.

The V.-T. VM. showed a strong signal being applied to the diodes of the 2nd-detector, plenty of current available to operate the A.V.C. A test of the plate current of the A.V.C. controlled tubes showed that they were not being biased by the strong signal, proving that the A.V.C. was not working. Checking all the accessible A.V.C. resistors showed them to be OK. One 50,000-ohm resistor mounted up inside one of the I.F. transformers was so isolated by high-resistance resistors as to make testing of it difficult and uncertain due to resistor tolerances.

As this resistor occupied a rather important position in the circuit, I "pulled" the I.F. transformer and dismantled it to check the resistor. Immediately on seeing the resistor the trouble was apparent. Instead of having the orange dot of a 50,000-ohm value, it had the brown dot of a 500-ohm value. The resistor was original equipment, and because a factory operator had mistaken brown for orange, the owner of this set had 5 years of very poor tone!

(No signature.)

● **Annoying Hum, Plus Blasting on Strong Signals.** A standard set had an annoying hum, and would play fine when tuned to a weak station, but would blast and distort on strong signals. The nature of the complaint indicated the A.V.C. action. The high impedance of the circuit necessitated the use of a V.-T. VM., a Weston Model 772 or similar analyzer.

I fed a modulated signal into the receiver with a signal generator and began testing the A.V.C. distribution circuit. I found that one of the filter condensers acted as a voltage divider across the A.V.C. network, reducing the control voltage causing distortion and blasting on strong signals. I replaced this condenser with one of similar value in good condition and the set played OK, but still had the hum.

I tested the power supply filter condensers for leakage, and found them to be well within the permissible leakage, but by measuring the A.C. voltage across the 1st filter condenser with a V.-T. VM. I found it above normal. By changing from an 8 to a 12 mf., the hum dropped to normal.

C. H. ROBINSON

● **Only Local Stations, with Distorted Tone.** A Philco Model 675 receiver allowed only local stations to come through, and they were badly distorted. Plate, screen-grid and cathode voltages checked OK with the normal 1,000 ohms/volt meter. When the set was tuned through the local stations signal, the signals came in and out with a blop, indicating trouble in the A.V.C. circuit.

A careful check was made of the A.V.C. circuit with a supersensitive meter and the filter condensers in the A.V.C. grid-return circuit were leaking 0.5-meg., the filter resistors in the same circuit had trebled in value. These parts were replaced, but the set was still distorted.

On checking, the coupling condenser in the 1st audio stage was found to be leaking about 1 meg. The set still was distorted. The grid bias of the output tubes were measured and found off about 3 volts. The

(Continued on following page)



FREE... TUBE TESTERS OR OTHER SERVICING EQUIPMENT LEADING MAKES!

Here's the chance of a lifetime to get the tube testing equipment you always want and need. National Union now makes it possible for you to choose from all the newest models of leading instrument manufacturers . . . every one guaranteed to test all the latest tubes! See your National Union jobber or send coupon. Only a small deposit is required—refunded as merchandise credit when the required number of points is reached, based on your purchases of N.U. tubes and condensers. Ten years and thousands of satisfied dealers testify to this easy way to obtain necessary shop equipment.

**Can you test...
LOKTALS • BANTAMS •
"S" TYPES ?
35,45,50,70,117 VOLT
HEATER TYPES ?**



N. U. QUALITY IS THE BY-WORD OF THE SERVICE ENGINEER

Service Dealers: Increase your volume, give better satisfaction to your customers, protect yourself from cut price competition . . . THEN WORK WITH N.U. . . . All our policies and sales promotions are aimed to build up you and your business.

GET A NEW TESTER Free!

Ask Your Jobber or Write NATIONAL UNION RADIO CORP. 57 State Street, Newark, N. J.

New! Tear out this ad, write your name and address in the margin, and mail it in for your copy of the **NEW AMATEUR RADIO CATALOG.** It is chock full of the latest nationally advertised amateur equipment. Everything is fully guaranteed, shipped within a few hours of the time your order comes in—and everything is sold on **WARD'S TIME PAYMENT PLAN!** Write Dept. RZ-35.

MONTGOMERY WARD
CHICAGO

WARD'S 1940 RADIO CATALOG

Please Say That You Saw It in RADIO-CRAFT

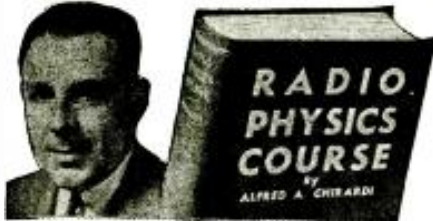

Learn from Ghirardi
all ABOUT RADIO IN ONE BIG \$4 BOOK

If Alfred A. Ghirardi, the renowned radio engineer and authority on radio instruction, should come to your home and personally teach you radio—would you be willing to pay his street-car fare? What a question! You'd eagerly pay a hundred times that trifling sum for the advice and counsel of this expert—the man who has written half-a-dozen of the world's leading textbooks on radio, and who has contributed regularly for years to leading technical journals in the field. Well, this acknowledged authority is offering his services to you right now in the form of—

A \$50 Course Complete for only \$4

Mr. Ghirardi could readily have put this great wealth of practical radio knowledge into some other form—and priced the lessons at \$50.00, or even more. But he has preferred to share it with everyone sincerely interested in any branch of radio as a profession or hobby. So the half-a-hundred personal-instruction lessons of his world-famous Radio Physics Course come to you bound in one whopping-big book—nearly 1,000 pages; 36 chapters; 508 diagrams and illustrations—the most comprehensive, thorough, crystal-clear learn-at-home course ever written on every branch of Radio, Electricity, Television, Sound and Cathode-Ray Tubes. And best of all—the price of this complete course is only \$4—less than a dime a lesson!

Widely used in Army and Navy Schools
What stronger proof of its superiority than the fact that scores, yes hundreds of copies of this very course are in daily service in the technical radio training schools of the Army, Navy, Marine Corps, G.C.C. and Coast Guard. Powerful endorsement this, of the soundness and practical value of Ghirardi's Course, because the requirements for any Government-Approved instruction text are extremely rigid. Add to this the fact that Ghirardi's Radio Physics Course is used and praised by more beginners and leading private radio and technical schools than any other radio text in the world! Why? Because this course is **THE TOPS!**

- ALL YOU NEED TO KNOW**
Here are the subjects covered in the various chapters. Read them:
1. Radio Broadcasting System.
 2. Sound, Speech, Music.
 3. Electron Theory; Elec. Current.
 4. Elec. Units; Ohm's Law; Resistance.
 5. Elec. Circuits; Batteries.
 6. Magnetism.
 7. Electromagnetism.
 8. Electromagnetic Induction.
 9. Inductance.
 10. Capacitance; Condensers.
 11. A. C. Circuits.
 12. Filters.
 13. Measuring Instruments.
 14. Radio Waves.
 15. Broadcasting.
 16. Receiving.
 17. Vacuum Tube Principles.
 18. Vacuum Tube Characteristics.
 19. Vacuum Tube Construction.
 20. Vacuum Tube Detector and Amplifier Action.
 21. Radio Frequency Amplification.
 22. "Superhets".
 23. R.F. Amplifiers; Tuning Coils.
 24. Audio Amplifiers.
 25. Speakers.
 26. Battery-Operated Receivers.
 27. Power-Supply Units.
 28. Elec. Receivers.
 29. Automobile and Aircraft Radio.
 30. Phono Pickup; Sound Systems.
 31. Short-Wave.
 32. Photoelectric Cells; Cathode-Ray Tubes.
 33. Television.
 34. Antennas and Grounds.
 35. Testing; Servicing.
 36. Sound Pictures.
- ... 856 Self-Review Questions!

START LEARNING RIGHT NOW

Start now—and you don't even need to risk a single penny to see and examine this great book. Mail the No-Risk Order Form below. Take advantage of our Special Offer of a—

5-DAY TRIAL
Read the book for 5 days. If not fully satisfied, return it in good condition and get your money refunded at once. Our risk!

ORDER NOW before prices GO UP!

RADIO & TECHNICAL PUBL. CO. Books Dept. RC-20
45 Astor Place, New York, N.Y. Shipped Postpaid Anywhere

Enclosed find \$4 (\$4.50 foreign) for my copy of Ghirardi's "RADIO PHYSICS COURSE" with your 5-day Money-Back Guarantee.

NAME
ADDRESS
CITY STATE

Please send me free descriptive literature about "RADIO PHYSICS COURSE."

BE SURE TO READ THE ANNOUNCEMENT WHICH APPEARS ON THE INSIDE FRONT COVER OF THIS ISSUE.

3 BAND COIL KIT
Tunes from 15 to 550 Meters

Kit includes:
1 3-Band antenna coil.
1 3-band osc. coil.
1 2-gang .00045 mfd. tuning condenser.
1 300-600 semi-var. padder.
1 .001 fixed padder.
Complete instructions and wiring diagram.

Special not price **\$1.69**

Complete parts list sent on request

ARROW SALES COMPANY
619 W. RANDOLPH ST., CHICAGO, ILLINOIS

(Continued from preceding page)
grid resistor in this circuit had changed in value. This voltage, measured at the socket, required the use of a supersensitive meter. The set was rebalanced using a sensitive output meter, but when I came to adjusting the A.V.C. circuit, I could not find a zero position for this transformer.

With the supersensitive meter I measured the voltage across the discriminator network, input side, and there was always some voltage across this network, when there should have been a zero reading when the set was properly tuned. With the supersensitive meter, the discriminator winding in the 2nd I.F. was shorting from 1.5 to 6 ohms. After replacing the transformer and rebalancing the set, perfect reception was obtained.

KEITH F. MARTIN.

MAILBAG

(Continued from page 480)

I am unable to find the time and money. You can be sure of the extent of my exasperation when I read of a person writing in for a T20 Xmtr circuit! The woods are full of them. My Thordarson Manual has a few.

Now although I derive a goodly share of my income from radio service, it is also a hobby to a certain extent. From the days when we tried to get quality from a UV201 output on up to the present 2A3's and 6L6's I have been interested in quality. So you see the basis of my enthusiasm for November Radio-Craft—it is full of worthwhile articles on amplifiers and service apparatus.

The above should give you an idea of what I want in a Radio Magazine—together with the admission that you have it! So keep up the good work.

F. N. KENNEY,
Troy, Ohio.

And there you have the other side of the story. What to do?

DID MR. McALLEN SLIP UP?

Dear Editor:
Re: Operating Notes, concerning Mr. Guy E. McAllen's idea of manufacturing Spray Shield Tubes with liquid solder as mentioned in Operating Notes in your December, 1939, issue, I should like to point out that liquid solder, at least all of it that I have ever encountered is an insulating substance, while the spray on a Rogers Spray Shield is an exceptionally good conductor and acts as, and is, a shield.

Of course Mr. McAllen's idea worked out as the other tubes used in the vicinity were spray shielded but just let him try and replace all the tubes with his painted beauties, line the radio up properly and see what happens. Why not replace the oscillator tube with a plain glass tube, pro tem, and send for a Rogers Spray Shield tube? (which he will eventually have to do anyway when other tubes wear out as they will in time).

I have every issue of your magazine since 1930 but for business reasons am a newsstand buyer as I have had many radio sets come to me for repair through buying Radio-Craft at a newsstand. I might say I would not part with my back copies as I find them not only very useful, but enjoy looking back in the old issues and comparing our old troubles with the new. Truly one can say that the old "screwdriver, pair of pliers, soldering iron, and cheap voltmeter" days are over. One wonders what next.

E. P. SIDALL,
Victoria,
British Columbia.

SELLING AND INSTALLING "ELECTRIC EYE" EQUIPMENT

(Continued from page 461)

or two resistors and one or two condensers are employed in the usual circuit, these can be easily checked or replaced for testing purposes. A simple photo-cell circuit is illustrated to give you some idea as to the method of connection usually employed.

You will find it worthwhile to get into this profitable new field. The writer will be pleased to help any radio Serviceman in planning photocell installations or in selecting the proper equipment.

This article has been prepared from data supplied by courtesy of Allied Radio Corp.

Camera Trap Catches Burglar
CRYSTAL LAKE, Ill., Nov. 2 (A. P.).—Dr. E. L. Brunswick caught a burglar with his camera and a lot of ingenuity.

The doctor has a filling station as a sideline and photography as a hobby. He rigged up his camera in the station and devised an electric-eye arrangement, so that if a prowler walked through the beam a flashbulb would be set off and the camera would make a photograph. Also the flash would set off a siren.

The night of November 7 the mechanism operated. Sheriff Lester Edinger, some days later, questioned Harold Lewis, 19 years old, a Woodstock farmhand about some petty thefts.

Dr. Brunswick's flashlight picture was a likeness of Lewis and yesterday the youth confessed, also admitting a series of burglaries in northern Illinois and southern Wisconsin.

This newspaper clipping is proof positive that a black-light beam and a photocell have their uses.

3-TUBE ULTRA-COMPACT DEAF-AID

(Continued from page 457)

and all of the condensers, resistors, variable controls, and switches are of standard parts; and, therefore, are easily replaced anywhere in the country. This makes the instrument easy to service and eliminates the necessity of returning it for repairs should something go amiss. It is interesting to note that the volume and tone controls measure less than 1/4-inch in diameter!

Looking at the open view of the instrument the tube at the left is the HY155. All the equipment shown in this photograph, except the earphone at the bottom, fits into the leather case shown in the accompanying view.

TECHNIQUE

Servicemen should point out that it is more important to properly adjust the tone control to compensate for high- or low-frequency compensation by the human ear than it is to turn the volume up to an excessive amount.

It has been claimed that 1 in every 7 or 8 persons—or more than 10,000,000 people in the U.S.—have difficulty in hearing. In some cases it is the high notes that lend clarity to speech, and in other cases it is the low notes that supply volume, which are

Please Say That You Saw It in RADIO-CRAFT

lacking. It is important to note that learning to hear properly with any type of hearing-aid requires a certain amount of experience or practice. For this reason a hearing-aid should not be discarded if it does not immediately fulfill all expectations.

It frequently occurs that the hearing-aid is used by a person whose auditory system has not been active for a number of years, and hence it may require some time to build up this auditory system to perceive and understand voice and music, just as it is necessary to gradually train any other previously unused organ to assume its place in the scheme of things. A corollary would be that of a limb which had been in a cast or splint for some time which requires some degree of exercise before it can be used.

It is also noteworthy that a person whose hearing is comparatively good is not an ideal person to adjust a hearing-aid by ear for one whose hearing is defective. (Instead, special frequency tests should be made.)

Still another point which Servicemen should keep in mind is that bone conductors are more effective where the hearing is less normal. For example, unless the volume is increased considerably, it is seldom possible for a person whose hearing is normal to hear by means of a bone conductor unless the ears are first covered over so as to exclude all external sound.

As tube-type hearing-aids come into more common use, Servicemen who have made it their business to keep abreast of developments, will find that they will be the first to profit from the repair and replacement business which results. *Radio-Craft* will continue to present information on new developments in this field as rapidly as it becomes available.

MY SMALL-TOWN SERVICE SHOP

(Continued from page 476)

"tuning eye" hookups we hit upon one that was in an issue of *Radio-Craft* way back when the 6E5 tube first hit the market. We built up this using 4 tubes instead of just one and by using this with our signal generator we had a smooth-running trick for finding where the signal was hitting into trouble. It did not look as well as the new channel testers and was not as elaborate but it did a swell job, and saved us time and money, and that was the main issue. Cost—about \$13.

These instruments were not built up in a week or month but just in spare time throughout many months. We mounted these instruments in a panel constructed of plywood (Masonite was not readily available), well sanded, and then we applied about 3 coats of clear varnish, and finished off with a couple of applications of Fibber Magee's Johnson's auto wax. All finished, we had our competitor's equipment out-classed in looks and efficiency 100 per cent, at about 1/3 the cost.

We have now been in this town for 18 months and are enjoying good business. It is now rumored that our competitor who has been repairing sets here for the past 12 or more years is planning to move to Florida—not enough business here for 2 he says. We wonder if our having equipment that enables us to do a better job at a better price and in most cases turn it out in one day's time has anything to do with this move.

AT LAST!

The March, 1940, issue of *RADIO-CRAFT* will continue the article "How to Convert a 5" Teletype Kit to Receive 9" Images" which, due to necessary experimentation, was held up. It was worth waiting for!

Speed up YOUR RADIO SERVICE WORK with Ghirardi's 2 Helpers

THEY'VE MADE ALL MY SERVICE JOBS EASY!

CASE HISTORIES—Plus!

Here's a helper for you that will do many a full day's work, yet you pay it no wages. Just get this new Ghirardi manual size Handbook—and it will work in your shop—and you'll get the time and money it will save you. It gives you ready help for spotting trouble and making repairs in practically every set ever made. It provides you with the best of a table of valuable service data of every description—118 large pages full of it.

Here, at last, is a book that gives you in 1 source a simple service data very kind of shop-reference service data you really need—look for it, every day.

PRACTICAL JOB DATA

- 3,313 Case Histories—Trouble Symptoms and Remedies for 113 sets, compiled from actual Service Records. This is by far the largest and most authentic Case History compilation ever published.
- I-F Peaks—Over 1,600 Lists for Alignment of all Superhets, old and new.
- Auto-Radio-Gear Ratios and Link Directions of Timing Controls of all sets; Installation and Gear Position Systems Data for all cars.
- Special Interference Elimination Instructions for over 80 cur-meches; Electrical Wiring Diagrams, etc.
- Other Data—Over 100 more pages of data, including Quick Trouble-Shooting Charts; Servicing Home Receivers; Servicing Int. Communicators; Trade Directories; Charts, Tables of Tubes, etc.

Basic Course in SERVICING METHODS

This big Ghirardi book brings you complete training in modern servicing instruments and the most recent tried and proved "factory methods" to employ in your radio service work. It's a complete home-study radio servicing course all in 1 handy volume! You get the basic theory so essential—how every type of test instrument works, how to use them, how to build them yourself, how to make all kinds of set repairs, etc. Man!—this book is positively alive with helpful information! Bring your servicing methods up to the minute. Don't fall behind! Step out ahead! Get this "Ghirardi" dose under your belt!

SERVICING DETAILS EXPLAINED

- Test Equipment—420 pages of Theory, Descriptions, Diagrams of all Commercial Instruments, How They Work, Construction Data, etc.
- Trouble-Shooting—254 pages of newest short-cut methods for tracking down all types of different receiver troubles.
- Repairing—184 pages of advanced "Factory-Method" for Superhet Alignment, Interference Elimination; Repairing of all sets, etc.
- Special Problems—442 pages on Auto-Radio Servicing and Installation; Servicing All-Wave Sets, High Fidelity Sets, AVC and QAVC circuits; Seltink and Advertising, etc.

RADIO Trouble-Shooter's HANDBOOK

518 Pages-134 illus.-Standard Manual Size (8½x11) Fabrioid Bound

MODERN Radio SERVICING

1300 Pages - 706 illus. - 720 Review Questions - 766 Topics

Money-Back Guarantee

\$6.50 for BOTH BOOKS

USE THEM 5 DAYS

Radio & Technical Publ. Co., Dept. RC-20
45 Astor Place, New York

Enclosed find payment for said rush to me. I request you to send me a money-back guarantee. I have received your MODERN RADIO SERVICING at \$4 (\$4.50 for the TRUBLE SHOOTER'S HANDBOOK) for \$3.50 (foreign).
 RUSH \$6.50 (foreign)
 BOOK at \$6.50 Special Combination price. (\$7 foreign.)

NAME _____ STATE _____
 ADDRESS _____
 CITY _____
 Please send me FREE illustrated 4-page circular describing these 2 books.

MAIL TODAY!

NRPDA
DISTRIBUTORS ASSOCIATION

THE MARK OF AN ETHICAL MECHANIC OF ADVERTISING RADIO DEALERS

SWINGS INTO ACTION

Primarily the aim of the Association is to return to the Distributor, the Dealer and the Serviceman the profits which are legitimately HIS! This can only be accomplished by raising the standards of ethics of merchandising within the Industry.

Names of Member Jobbers in your territory will be supplied if you will address the Executive Secretary of the Association.

TEMPORARY OFFICE OF THE EXECUTIVE SECRETARY
 5 West 86th Street
 New York, N. Y.

Please Say That You Saw It in *RADIO-CRAFT*

WHY AREN'T YOU TRAINING for a TELEVISION JOB?



Insure Your Future! Train Now! RADIO & TELEVISION ENGINEERING

• Don't get stuck! The great field of radio offers amazing opportunities for men in the expanding fields of radio and television engineering. HERE is the opportunity for you to train in your spare-time for a better job! CREI has trained hundreds of ambitious men for important positions in broadcasting, aviation, marine and police radio. Constant improvements demand better men for the important, high-paying jobs... and that means a better job for YOU—if you TRAIN NOW!

Send today for complete details!

Write for Your Free copy of "The CREI Tested Plan"

CAPITOL RADIO Engineering Institute

Dept. RC-2, 3224 16th St. N.W., Washington, D.C.

FREE TRIAL OFFER

New Remington Deluxe Noiseless Portable! AS LITTLE AS



10¢ A DAY

The New Famous Remington Deluxe Noiseless Portable that speaks in a whisper, is yours for as little as 10¢ a day. Brand new. Standard keyboard. Automatic ribbon reverse. Variable line spacer. Touch regulator and all the conveniences of the finest portable ever built. PLUS the NOISELESS feature. Act now. Send coupon TODAY for details.

You don't RISK a Penny

We will send you the Remington Deluxe Noiseless Portable for 10 days' free trial. If not entirely satisfied, send it back. We pay all shipping charges.

FREE Typing Booklet, Special Carrying Case

You will receive FREE a complete simplified booklet on Touch Typing prepared by experts. A handsome sturdy carrying case is included in the price. No obligation. Mail coupon for full details—NOW.

Remington Rand, Inc. Dept. 189
165 Washington St., Bldg. 30, N.Y.
Tell me, without obligation, how to get a Free Trial of a new Remington Noiseless Portable, including Carrying Case and Free Typing Course on terms as low as 10¢ a day. Send Catalogue.

Name.....
Address.....
City..... State.....

GREATEST SLIDE RULE VALUES!



10 inch enameled slide rule, made of kiln dried genuine mahogany wood, has auxiliary removable magnifier with pins to fit cursor runner. This rule has inch, millimeter, and log and trigonometric scales. Packed in individual carrying case. This rule is equal in performance to a \$10.00 rule. Our price, \$1.00. Special price, P.P. prepaid anywhere.

8 inch slide rule in case with 36 page illustrated Book of Instructions & Examples. Parcel Post Prepaid **40c**

GOLD SHIELD PRODUCTS
Dept. RC-240 350 Greenwich St. New York

PATENTS—TRADE MARKS

Booklet concerning Inventions & Patents Form "Evidence of Conception" with instructions for use and "Schedule of Government and Attorney Fees"—Free

LANCASTER, ALLWINE & ROMMEI.
Registered Patent Attorneys
436 Bowen Bldg. Washington, D. C.

SCRATCH FILTER DESIGN

(Continued from page 473)

Maximum Loss in Decibels = $-20 \log t_r$ (5)

To evaluate X_r , it is necessary to choose some point other than that of maximum loss on the curve which the equalizer under design is to approximate. Call the transmission ratio at this point t_1 , and its frequency f_1 . From equation (2),

$$t_1^2 = \frac{R^2 + X_r^2 \left(\frac{f_1}{f_r} - \frac{f_r}{f_1} \right)^2}{(R_o' + R)^2 + X_r^2 \left(\frac{f_1}{f_r} - \frac{f_r}{f_1} \right)^2}$$
 (6)

Solving for X and substituting for R its value from equation (4) gives the expression

$$X_r = \frac{R_o'}{\left(\frac{f_1}{f_r} - \frac{f_r}{f_1} \right) (1 - t_1)} \sqrt{\frac{t_1^2 - t_r^2}{1 - t_1^2}}$$
 (7)

If the frequency f_1 is selected above resonance, a minus sign should be placed before the right-hand side of (7).

Having evaluated the reactance of the coil and condenser at the frequency of resonance, the inductance and capacity are obviously

$$L = \frac{X_r}{2\pi f_r} \text{ and } C = \frac{1}{2\pi f_r X_r}$$
 (8)

Since R is the total effective resistance of the branch circuit, it includes the resistance of the coil, and the value of the resistor. The sharpness of the resonance is limited

by the value of Q of the coil, that is $\frac{X_r}{R}$, at the resonance frequency. The required Q of the branch circuit to meet a given condition of maximum loss (represented by $\frac{1}{t_r}$),

and a given loss $\left(\frac{1}{t_1} \right)$, at a selected frequency (f_1) may be determined from

$$Q = \frac{X_r}{R} \frac{1}{\left(\frac{f_1}{f_r} - \frac{f_r}{f_1} \right)} \sqrt{\frac{\left(\frac{t_r^2}{t_1^2} \right) - 1}{1 - t_1^2}}$$
 (9)

Or, if it is desired to know what value of t_1 may be obtained, a given distance from f_r with a coil of given Q, this may be determined from

$$t_1 = \sqrt{\frac{1 + \left(\frac{f_1}{f_r} - \frac{f_r}{f_1} \right)^2 Q^2}{\frac{1}{t_r^2} + \left(\frac{f_1}{f_r} - \frac{f_r}{f_1} \right)^2 Q^2}}$$
 (10)

For the adjustable R-C arm intended to drop the upper end of the spectrum to reduce noise, the values may be obtained experimentally.

ELEMENT-VALUE CURVES

The graphs in Fig. 4 may assist the selection of element values. These curves show the effect of varying the resistance only, the source and load impedances, and the capacity being fixed. The abscissae of these curves is a constant times frequency. The curves may be placed anywhere on the frequency scale by assigning the appropriate value to the constant which is equal to $2\pi C R_o'$.

For example, it may be desired to so locate the family of curves that the abscissa evaluated at 1.0 be 2,000 cycles. Then the horizontal scale is converted into a frequency scale by multiplying all abscissae by 2,000. Furthermore, C can then be evaluated by setting $f = 2,000$ in the expression

$2\pi f C R_o' = 1$ and solving for C, yielding a value

$$C = \frac{1}{2\pi \cdot 2,000 R_o'} = \frac{160}{R_o'} \text{ mf.}$$

Then, if, for example, R_o' is to have a value of 10,000 ohms, C is 0.016-mf.

It will be observed that reducing R decreases the response at the highest frequencies but increases it at the middle-high frequencies. Whether this effect at the middle-high's is desirable is somewhat debatable but the writer's experience recommends that the entire high end should drop off as the control is changed. There are several ways in which this may be accomplished, but one method is to vary the effective circuit resistance (effective resistance resulting from the parallel combination of the source and load resistance) as the value of R is varied. This may be done by inserting a variable resistance in series with the circuit between the source and the point at which the R - C arm is shunted across the circuit, and, if the source resistance is high as compared with the load resistance (as will be the case if the arm is inserted between stages in a resistance-coupled amplifier), variation of this series resistance will have rather little effect on volume over a considerable range. This series resistance would be mounted on the same shaft as that which varies R.

There is no one desirable law of variation of circuit resistance with variation in R. The perfect job from a geometric standpoint would be to maintain constant the frequency ($f_{1/2}$) at which all the curves have a loss equal to $1/2$ their ultimate loss as illustrated in Fig. 5. That is, arrange things so that for a curve which has a maximum loss of 6 db, the frequency at which the loss is 3 db, is the same as that at which an 8 db. curve has a 4 db. loss or a 10 db. curve shows a 5 db. loss. This is accomplished if the relation between R and the effective circuit resistance, R_o' , is maintained in accordance with the relation

$$R_o' = \frac{X^2 - R^2}{R} = R \left(\frac{X^2}{R^2} - 1 \right)$$
 (11)

where X is the reactance of the condenser at the chosen frequency where all curves have half their maximum loss. When this condition is fulfilled, the loss at this frequency expressed as a ratio is given by

$$1 = \frac{X}{R}$$
 (12)

or, $1 = \sqrt{\frac{R_o'}{R} + 1}$ (13)

The design procedure may be as follows:

- (a) Select the frequency at which the curves should have half their ultimate loss.
- (b) Determine at how small a half-maximum loss it is important to maintain the vertical alignment of the curves (say 3 db., for which $l = 1.41$).
- (c) Decide upon the value of R_o' , the effective resistance of the circuit, and consider this the minimum value of R_o' .
- (d) Calculate R from equation (13) for the loss selected in (b).
- (e) Using this value of R, calculate X from equation (11). Since f was selected in (a), C may now be determined.
- (f) Now, with this value of X, calculate values of R from (12) for sufficient values of loss to permit drawing a curve.
- (g) Compute the corresponding values of R_o' from (11). The added series resistance $\Delta R_o'$ is the difference between these values

of R_o' and the value per (c). These differences should be plotted against the values of R per (f). The resulting curve gives the relation that should be maintained between R and the added series resistance. For refined design, correction to ΔR_o should be made for the shunting effect of R_i . The corrected value of ΔR_o , which we will call $\Delta R_o'$ may be found from the expression

$$\Delta R_o' = \frac{R_i R_o'}{R_i - R_o'} - R_o \quad (14)$$

where $\Delta R_o'$ is the required added resistance corresponding to R , R_o and R_i are respectively the generator and load impedances of the original circuit and R_o' has the values calculated in (g).

SOUND ENGINEERING

(Continued from page 468)

can be used instead). The 2nd-stage amplifier employs a 6C5 only because you have used this tube before. If higher gain is desired, however, I would suggest that you use the 6SF5 as indicated in Fig. 2A. This change will be sure to provide more than sufficient gain to obtain full power output with your ribbon microphone. The 6SC7 is used in a self-balancing type of phase inverter circuit.

Although two 25Z6 rectifiers will safely handle the power requirements of the amplifier, the use of 3 will provide a higher safety factor. It might be advisable to introduce small resistances in series with each plate, so as to insure equal loading of all rectifiers. This revised filter circuit is indicated in Fig. 2B. It will not materially affect the power output or the regulation of the amplifier, but will insure safe peak currents through the rectifier, should the amplifier be abruptly turned off (long enough to discharge the filter condensers) and then turned on while the rectifier cathodes are still hot enough to initiate rectification.

The type of circuit you have described is particularly susceptible to parasitic oscillations. This peculiar condition can easily be observed by connecting an oscilloscope to the output of the amplifier and feeding a low-level signal into the input. It will be noted, that as the volume control is turned up the waveform seems to crack-up and produce what is known as parasitics. This condition prevents the attainment of full-rated output from the amplifier. A number of contributing factors cause this phenomenon. Some of the most common causes are coupling between input and output of 25Z6's, common coupling between screen-grid, plate and control-grid through bypass condensers or common ground leads.

One of the simplest remedies is to insert R.F. chokes in one pair of output-tube plate leads, as indicated in Fig. 2C. These should be composed of 400 turns, of No. 32 wire, wound on a form 3/4-in. long x 3/8-in. dia.

Wire-wound grid resistors (500 ohms) may also be inserted in each of the grid circuits of the output tubes, as indicated in Fig. 2D.

If hum is to be kept at a very low level it might be advisable to use a separate small filament transformer to operate the heaters of the tubes used in the 1st 2 stages as indicated in Fig. 2E. This precautionary measure will prevent the development of 6 volts A.C. between the heater of the 2nd-stage tube and ground. At the same time it makes available a very convenient pilot light voltage source.

The same precautions should be exercised in constructing this amplifier as would be employed in making any high-gain unit.

SOUND EQUIPMENT

(Continued from page 475)

be grouped as closely together as possible—and as near to the microphone as is practical. When the loudspeakers are not closely grouped together, the sound from each speaker will not reach the audience at the same time. Consequently the words and music are heard twice by the audience within a very short period of time. The result is a blurred sound.

When using only one speaker it should be placed above the microphone and as high as possible. Where 2 speakers are used, one should be placed to the right and the other to the left of the microphone, both reasonably high. With 4 or more speakers, half the speakers should be placed on one side and half on the other side of the microphone, all reasonably high. In all cases the speakers should be somewhat nearer the audience than the microphone. Whether you use baffles, projectors or trumpets, these speaker positions always give you the best results whether you use them indoors or outdoors.

There are a few exceptions to this rule; for instance, in gymnasiums, skating rinks, circus tents, etc., the speakers are placed in a cluster, suspended in the center of the room. They should be mounted as high as possible, pointing downward in all directions. Another exception is the stadium or grandstand. Here the horns are in groups of 2, equally spaced along in front of the grandstand. In picnic grounds the speakers may be placed at the most used locations or at random.

CORRECT SPEAKER PLACEMENT

In Fig. 2A, the speaker is placed *above and near* the mike. This is the correct placement because the entire audience hears a single word (in this case, "Hello"). Note how sharp and clear the word appears . . . that is because the audience hears it only once. It takes a short time for sound to travel, and by having the speaker and mike close together, it requires about the same time for the sound to reach your audience from both your lips and the speaker.

Now look at the picture in Fig. 2B. The word, "Hello" is raspy, hollow and indistinct. This is because the speaker is too far from the mike. The word "Hello" is heard first from his lips, and an instant later from the horn. Your audience heard 2 words—so close together it became one harsh, distorted sound.

It is best to use 2 or more speakers. They should be placed 15 or 20 feet on each side, above, and a little in front of the mike; and 10 to 15 feet above the floor or stage, if practical. In this way the sound coming from each loudspeaker reaches your audience at the same time. As the volume is equally divided between the 2 speakers, the sound will appear to come from a point directly between the 2 loudspeakers, which is the usual position of your microphone.

In Fig. 2C the sound is barely reaching your audience. The speaker is focused too high and throws the sound over their heads. This wastes most of your amplifier power.

Now look at the sketch of Fig. 2D. The speaker is mounted at the correct height and tilted slightly downward so the entire audience receives the full benefit of your sound system. This holds true whether you are using one or more speakers. When only one is used, it should be mounted 10 to 15 feet high, directly over the microphone.

A speaker should *never* be located *behind* the audience. If the people in the back of your church or auditorium have

(Continued on following page)

"Get THE BIGGEST CATALOG and BIGGEST VALUES in ALL RADIO!"

FREE 204 Pages 15,000 items

60 Newest Sets!

Amazing values in new Knight Sets for every purpose, with "Air Magnet" and other newest features — remarkable values in portables, phonoradios, electric phonographs, and stereo accessories!

Newest Ham Gear!

Most complete amateur listing in all radio—all latest communications receivers, transmitters, transceivers—Rotary Beam, Television, etc., all standard lines at lowest prices—and a new, lower-cost Time Payment Plan!

Complete Parts Section!

Save money on all radio parts. ALLIED offers rock-bottom prices on parts for every purpose, tubes for all radios, books, tools, etc. Compare our prices—see our special section of Super-Values! Also complete Test Equipment, in ALLIED's Super Catalog!

Build Your Own!

Dozens of new kits, parts and prices are shown in ALLIED's Catalog. Write for Free Parts Lists on any circuit. New revised edition of Radio Builders' Handbook tells how to select circuits, read diagrams, build sets, etc. Easy to assemble—packed with useful data. Order by coupon below. **ONLY 10c**

FOR REVOLUTIONARY NEW P.A. SEE OUR AD ON PAGE 492

SEND THIS COUPON

833 W. Jackson Blvd., Dept. 2-B-0, Chicago, Illinois

Rush your FREE 1940 Supply Catalog.

Enclosed find 10c. Send Radio Builders' Handbook.

Name

Address

City State

Please Say That You Saw It in RADIO-CRAFT

Mr. Serviceman: FOR BETTER BUSINESS ... FOR BIGGER PROFITS DURING 1940 ...

JOIN RSA!

- ★ You belong in this big, live servicemen's organization that is really doing things for its members!
- ★ RSA secured cooperation with broadcasters to sell servicing to the public over the air. ★ RSA helps you to solve many difficult technical problems. ★ RSA sends you technical bulletins. ★ RSA does many other beneficial things—for you. Send now for complete details.



*Let's Grow Together
in 1940!*

RADIO SERVICEMEN OF AMERICA, Inc.

JOE MARTY, JR., EXECUTIVE SECRETARY
304 S. DEARBORN STREET, CHICAGO, U.S.A.

MAIL THIS COUPON NOW!

RADIO SERVICEMEN OF AMERICA, INC.
304 S. Dearborn St., Chicago, Ill.

Name

Address

City State

I am interested in RSA Membership. Tell me about it.....

I am enclosing \$4.00 for National dues and initiation. Covers dues up to Jan. 1, 1941, in accordance with special dues concession....

(Does not include Local Chapter dues where Local Chapters are organized.)

RC-240

(Continued from preceding page)
 trouble hearing, place the speakers as high as possible in a tilted position, and increase the volume. Do not place speakers under the balcony. Remember, too, that speaker placement is even more important when you are using the horn-type enclosure, because of its highly directional qualities. (See above.)

By following these recommendations and the few simple suggestions on this and the preceding pages, anyone can order the right sound system for his needs. And, when it arrives, you'll find it as easy to plug in and operate as your radio set.

This article has been prepared from data supplied by courtesy of Montgomery Ward & Co.

P.A. SALE TO SKATING RINK

(Continued from page 474)

long x 55 ft. wide x 22 ft. high. The building was originally constructed for a garage. A maple floor was laid and necessary railings used around the walls, which are of stone. This construction necessitated an unusually high degree of amplification. We found that this type of installation is a great deal different from dance halls, night clubs or any other type of installation, due to the fact that the music or voice is fed to the back of the skaters and they, in turn, carry the sound around with them. In other words, the same principle applies with reference to sound as with the heaters in the building—the music follows the current.

The photo of the Rollerdrome shows electric organ and amplifier (arrow), and the loudspeakers (circles).

This article has been prepared from data supplied by courtesy of Fuller Specialty Co.

NEWEST RADIO-DIRECTED BLIND-LANDING SYSTEM

(Continued from page 463)

reciprocal courses giving him definite orientation when approaching the airport from any direction, and this has been accomplished with a complete absence of spurious or false courses to the sides. Further, this new antenna system is adaptable to airport conditions and can be adjusted to eliminate wave interference peculiar to any particular airport.

A new type of receiving antenna has also been developed for the airplane. This antenna is fundamentally the same as the transmitting antennas and it is receptive to horizontally-polarized waves only. The basic field pattern is essentially circular in the horizontal plane. In order that a single antenna may be used for reception of both the localizer and glide-path waves, a special network was designed to be connected between both receivers and the one antenna.

DESIGNED TO MEET PILOT'S VIEWPOINT

The Civil Aeronautics Authority system has been designed throughout to make the pilot's indication as simple as possible to follow. He switches from the *radio range*, which is giving him his general directional guidance, to the instrument landing receiver when he is about 10 miles from the airport.

The pilot is guided from this point on by a single indicator with 2 cross pointers. This instrument appears directly before him on the instrument panel. The pointers, 1 vertical and 1 horizontal, are actuated by 2 constant beams of radio energy sent out by the transmitters at the airport. The vertical pointer, actuated by the *runway localizer* beam, shows the pilot whether he is to the right or the left of the correct

line of approach to the runway. The horizontal pointer, actuated by the *glide-path transmitter* beam, gives him his exact line of descent to the runway. Thus, when the pilot has both of his pointers in the correct position, 1 vertically and 1 horizontally, and flies so as to keep them there, he can bring his plane to a safe landing on the runway without regard to conditions of visibility at the field.

The pilot receives the signals of the inner and outer markers as pulsating flashes in small electric lamps adjacent to the cross pointer indicator—slower pulsations at the outer marker, rapid pulsations at the inner marker. He also receives these marker signals in his earphones—a low-pitched tone when he passes over the outer marker, a high-pitched tone when over the inner marker.

THE RUNWAY LOCALIZER TRANSMITTER

The *runway localizer transmitter* is a unit 76 ins. high, 30 ins. wide and 20 ins. deep weighing approximately 900 pounds. The frequency of transmission is stabilized by a 4,579.17 kc. quartz crystal. A series of multiplier stages produces a final frequency of 109.9 mc.

The rated output power which is unmodulated, is approximately 300 watts, with a total power input of approximately 2,000 watts at 220 volts single-phase alternating current. An important feature of this unit is its compactness. All R.F. circuits and power supply (exclusive of line voltage regulator) are contained in the single cabinet. The unit also contains control relays so that it may be remotely operated from the control tower.

Please Say That You Saw It in RADIO-CRAFT

A monitoring arrangement is provided in this transmitter which operates in conjunction with a *field monitor*. The field monitor is situated in front of the localizer house on a line between the localizer and the landing runway. The monitor is directly on course and receives the signals in much the same way as the receiver in the approaching airplane. The monitor output is returned to the transmitter where it operates the course indicator meter which shows the position of the course at all times. There is also a similar instrument in the control tower for observation purposes from that point and this is operated from the same field monitor.

The modulator unit is considered part of the localizer transmitting system. It is situated adjacent to the transmitter and modulates the transmitter output. The R.F. output of the transmitter is divided into 2 equal parts and is modulated separately at 90 cycles and 150 cycles before being delivered to the antenna system.

THE GLIDE-PATH TRANSMITTER

The *glide-path transmitter* has the same dimensions and weight as the runway localizer transmitter. The crystal frequency is 3,912.5 kc. and the output frequency is 93.9 mc. The rated output power is approximately 300 watts modulated at 60 cycles. The total input power is approximately 2,000 watts at 220 volts single-phase A.C. The tube lineup is the same as in the localizer transmitter.

All R.F. and power supply components (excepting line voltage regulator) are contained in a single cabinet as well as control relays necessary for remote operation from the control tower.

The transmitter contains a monitoring circuit for indicating the transmitter operation. This monitor also serves as a tuning aid during the transmitter adjustment. The monitor output is carried to the control tower for operation of instruments which indicate the position of the glide path at any time. In addition if the monitor output shall fall below a predetermined level, an alarm is sounded as an indication of trouble.

THE MARKER TRANSMITTERS

The *marker transmitters* are approximately 18 ins. high, 27 ins. wide and 15 ins. deep, and they weigh 150 pounds each. The crystal frequency is 4,166.7 kc. and the output frequency is 75 mc.

The rated output power is 5 watts modulated at 400 cycles for the outer marker and at 1,300 cycles for the inner marker. The 400-cycle modulation is keyed at the rate of 2 pulses per second and the 1,300 cycles at 6 pulses per second.

The entire transmitter is contained in a single portable unit. All R.F. and power supply circuits, modulator, keying and monitoring equipment are contained in the single unit. The transmitter and its associated line voltage regulator are installed in a small weatherproof house suitable for outdoor installations in positions where the unit will be unattended for long periods of time.

The transmitters are mounted on sliding shelves so that they may be easily pulled out of the small housings for servicing. While in this position, complete access may be had to all parts of the transmitter.

The transmitters are intended for remote operation and monitoring from the airport control tower. The transmitter monitor returns a signal to the tower where correct operation may be observed.

MONITOR AND CONTROL DESK

The monitor and control desk permits remote control of all equipment in the system.
(Continued on following page)

fast action • low priced TUBE TESTER

22.00 Only COMPLETE

TRIPLETT TRIPLE VALUE TUBE TESTER Model 1213

MODEL 1213 contains all sockets to test present-day tubes, including Locfals, the new Bantam Jr., the High Voltage series recently announced (including the 117Z6G), Single End Types, all regular Octal and Non-Octal, Pilot Lamps and Gaseous Rectifiers. Has Ballast Tube Continuity Test. Will not deactivate 1.4 volt or other type tubes . . . a positive assurance with any current Triplett tube tester. Filament voltages from 1 to 110. Has RED•DOT Lifetime Guaranteed Instrument. Complete in black baked enamel suede finish case \$22.00 . . . Dealer Net Price . . .



FOLDEX TUBE CHART

A folding "card-index" system, giving quick and complete tube data with the additional advantage of new tube supplements mailed free to registered users.

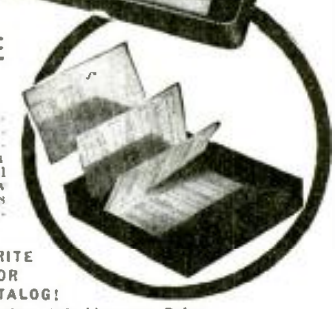

THE TRIPLETT ELECTRICAL INSTRUMENT CO. Bluffton, Ohio

WRITE FOR CATALOG: Section 162 Harmon Drive

COMPLETE RADIO COURSE \$1.95



Amazing Offer of R. T. I. Training GREATLY REDUCED

You still have a chance to obtain an exact reprint of the latest R.T.I. \$19.00 radio course for only \$1.95. This practical home study training, prepared by the famous Radio Technical Institute, is your chance to learn radio the pre-tested way. These courses are complete in all details and exactly the same as the much higher priced originals.

THOUSANDS OF GRADUATES
As a radio-minded person, you know that new developments make Radio the present-day opportunity field. Men like you studied Radio Servicing for a short time and today are making real money in radio. R.T.I. unique radio training will bring rich rewards to you. You can get ready quickly, inexpensively, easily, and in your spare time for a good job in radio.

ACCEPTED BY INDUSTRY
Forty-three leading radio manufacturers banded to prepare the authorized R.T.I. course. Just think what this backing by the radio industry means to you. R.T.I. practical training will give you facts and real service data you will need on the job. Hundreds of diagrams and illustrations will help you. You will pass quickly from lesson to lesson and in surprisingly short time will be ready to do real radio work and earn bigger money.

COMPLETE IN ALL DETAILS
R.T.I. course will give you all the radio training you need. No special previous education or experience is needed, but a knowledge of radio will be helpful. The lessons are clear, interesting, easy to master and use. Follows what you know nothing about radio before taking this home-study course are now leading servicemen in their communities. The special \$1.95 price of the complete course can be earned in a single hour of radio servicing. Get started now. Send for this practical radio course right away. You can't go wrong. We guarantee your satisfaction.

Arthur Gold, now a serviceman in Illinois, says: "From the very start I learned about practical equipment and methods. I was told how to open my own shop. You too can earn spare-time money on radio repair jobs before you reach the 14th lesson."

Your Guarantee
You must be pleased, or your money will be promptly refunded. We guarantee these courses to be exact reprints of the R.T.I. course. Reference: Liberty National Bank, Chicago; Hunt & Braintree, Chicago; Chamber of Commerce, of any magazine publisher.

3 COURSES IN ONE
R.T.I. course is really three complete essential courses combined. You get training in (1) Practical and Applied Radio, (2) Fundamentals of Radio Principles, and (3) Advanced Specialized Training. This is the training which will place you far above the average radio men—and you get this practical training for only \$1.95. There are over 40,000,000 radios in use. The R.T.I. streamlined course will pave the way to your success in Radio. A final examination may be taken and diploma obtained if wanted.

TELLS HOW TO USE INSTRUMENTS
The training is remarkably complete. Everything from simple facts to advanced radio problems. Many servicemen have found R.T.I. training excellent for brush up and study of modern servicing methods. This is the best buy in a radio education. Take advantage of the reduced bargain price today.

LATEST DATA
Yes, in the R.T.I. course you will find an explanation of A.V.C., how to use an oscilloscope, sound feedback, resonance action . . . every possible fact you must know to be the best radio serviceman. You get a real radio training. One of the BEST radio courses is yours for only \$1.95. Answer today.

NEW REPRINTED EDITION
Hurry your order to us today. There is a limited quantity of the courses left at the special bargain price. You are completely protected with our "you must be satisfied" or money-back guarantee.

FREE EXAMINATION COUPON
SUPREME PUBLICATIONS, Agents
3727 West 13th St., Room 305
Chicago, Illinois
Ship the complete R.T.I. Radio Course at the special reduced price. I may return the course for a full refund if I am not pleased.
 I am enclosing \$1.95, send prepaid.
 Send C.O.D., I will pay mailman \$1.95, plus a few cents postage.

NAME
ADDRESS

Please Say That You Saw It in RADIO-CRAFT

NOW ONLY 10c

NEW 1940 EDITION

68 PAGES

300 WAYS TO MAKE MONEY

careful tested schemes—actual experiences of men who have started on a shoestring—with less than \$10 capital. Money-Back Guarantee. "CASH IN" contains only tested ideas covering every type of full- or spare-time enterprise—it's a "masterpiece" in business ventures. 10 CENTS per copy. Sent POSTPAID anywhere upon receipt of 10 cents U.S. stamps or coin.

NATIONAL PLANS INSTITUTE
246-R FIFTH AVENUE NEW YORK, N. Y.

Treat Yourself or Your Friends to a PRACTICAL Gift!



"JIFFY" Magazine Binders

Sturdily built and covered with black fabricoid. Has two stamped metal ends with 12 spring wire separators. Magazines can be inserted and removed in a jiffy. No fuss—no lost time—no labor.

- No. 1. 12 1/2"x9 1/2", with 2-inch back for Radio-Craft, R.&T., Radio News, etc.—\$1.50
- No. 2. 10 1/2"x7 1/2", with 3-inch back for QST, Radio, Popular Mechanics, etc.—\$1.25
- No. 3. 8 1/2"x6 1/4", with 3-inch back for Reader's Digest, etc.—\$1.00

P.P. Prepaid in U.S. and Canada. Send for catalog containing full descriptions of many other interesting items.

GOLD SHIELD PRODUCTS

Dept. RC-240 350 Greenwich St. New York

BACK ISSUES OF RADIO-CRAFT ARE STILL AVAILABLE

If you have missed any of the important issues of *Radio-Craft* in 1939 and 1938, here is your opportunity to fill the gaps in your library. The nature of most of the articles appearing in *Radio-Craft* is such that they form valuable reference works on practically all branches of the radio field. The older these issues become the more valuable they are. All back issues of 1939 are available at the regular newsstand price of 25c. Back issues of 1938 can be obtained, but at a higher price—50c. Issues earlier than 1938 are either out of print or are available at varying prices depending upon their dates.

Send for your back numbers now while they last!

I WILL TRAIN YOU AT HOME
Be a **RADIO SERVICE EXPERT**

Clear, simple, fascinating lessons—practical work with experimental kits—make training easy and fast. Up to date R.T.A. methods under personal guidance of prominent engineer and educator, highly endorsed by leaders in radio industry. Spare-time profits soon pay for training.

START NOW—have your own business or fill yourself for well paid work with radio dealers, in factories, police, marine or television fields. **DON'T DELAY!**

Send AT ONCE for complete information and **BOOK FREE!**

RADIO TRAINING ASS'N. OF AMERICA
4525 Ravenswood Ave., Dept. RC-20, Chicago, Ill.

RADIO TECHNOLOGY

RCA Institutes offer an intensive course of high standard embracing all phases of Radio and Television. Practical training with modern equipment at New York and Chicago schools. Also specialized courses and Home Study Courses under "No obligation" plan. Catalog Dept. RC-40.

RCA INSTITUTES, Inc.
A Radio Corporation of America Service
75 Varick St., New York 1154 Merchandise Mart, Chicago

(Continued from preceding page)

tem as well as observation of the operation of all transmitters. The control tower operator may select the runway on which the plane may land in accordance with the prevailing wind direction. Selection of any given runway automatically places in operation the proper localizer, glide path and marker transmitters for the approach from that direction.

Calibrated instruments and signal lamps give quantitative and qualitative indications of the various transmitters. These indicators are operated by the transmitter monitors and indicate the position of the glide path, alignment of the runway localizer and correct operation of the marker transmitters. If the output of any transmitter falls below a predetermined level, visual and aural alarms indicate the trouble. The alarms also operate if the runway localizer course should shift sufficiently to cause an airplane following the course to land off the runway.

The top of the desk is a pictorial map of the airport showing clearly the position of the various runways and transmitters. Colored signal lamps represent each transmitter and are lighted when the corresponding transmitters are in operation. At the head of each runway is located a translucent miniature airplane which is lighted to show the direction of approach.

A pen recorder incorporated in the unit supplies a permanent record of the operation of the system. This instrument records the elapsed time a runway has been in operation, the output of each transmitter, and the localizer course alignment. This multiple function is accomplished with a single pen by recording successive short intervals of the operation of each unit.

WIDE TEMPERATURE RANGE

All transmitting equipment is constructed to operate continuously or intermittently within the temperature range between -40° C. and +60° C. inclusive and 0 to 90 per cent humidity. In this range, the power output variations are small and cause practically no changes in the characteristics of the system.

SERVICING QUESTIONS & ANSWERS

(Continued from page 474)

check for low resistance around switches; for the primaries, use a pair of phones with 0.1-mf. condenser in series. Pull the 6F6's and place a 5,000-ohm, 20-watt resistor across the screen-grids of the 6F6's to ground ("B+") as substitute load. Now check the plates of the tubes; and then the "B+" side of the primaries. The noisy primary will be audible on the plate side or louder than on the "B+" side.

REPEATED BURN-OUTS

(146) Walter E. Grim, Red Lion, Pa.

(Q.) I have in for repair an RCA 9TX-31 in which the dial light, and the heater of the 12SQ7 repeatedly burn out.

I replaced the resistor with a 25-ohm unit; and the dial light with a new tube. When I turned the set on, out went the heater of the tube again!

I checked for shorts and traced the wiring, and I think there is a mistake at the 12SQ7 socket, on which I have no socket data. The 12Q7GT has the control-grid connection atop the tube, and I figure the No. 6 terminal of the 12SQ7 should be the grid connection, No. 2 and 7 heater, No. 3 plate, 4 and 5 diode, and 8 cathode. The 12Q7GT

No. 6 terminal has no connection; that is why I figure No. 6 of this tube to be the control-grid.

Should not the wire on No. 6 terminal hook to the No. 3 terminal; the 10-meg. resistor from No. 6 to negative; and, a lead from No. 2 to negative? Or, just where else could I find the trouble?

(A.) The 12SQ7 is a single-ended high-mu duo-diode tube with approximately the same characteristics of the 6Q7. As the single-ended feature requires more or less shielding between grid and plate (same applies to all single-ended tubes of the new series) it was necessary to rearrange the pin positions, which are as follows:

- 1—shell or shield
- 2—control-grid
- 3—cathode
- 4 & 5—diodes
- 6—plate
- 7 & 8—heater

The 5 tubes in series have a voltage drop of 106 ohms, the 55-ohm ballast section has a voltage drop of 16.5 V. The pilot light shunt ballast should be approximately 33 ohms having a voltage drop of 9.9 ohms. The voltage drop being about 6 V. with the pilot light in shunt. There is a total voltage drop of 138 V. which indicates that the tubes are operated under the normal voltage. Therefore a short on the filament circuit is indicated. This may be in the tubes other than the 12SQ7 or across the filament prongs of the sockets.

TUNING DRIFT

(147) S. D. Pelone, Elmira, N. Y.

(Q.) A Sears, Roebuck & Co. 4400A (Howard HA-6) auto-radio set has developed a case of tuning drift. Voltages are OK. Vibrator, buffer condenser, dual 8-mf. filter condenser, all are new and of good quality, and the set was aligned. Now however it gradually gets weak to the point of non-reception, but by realigning by ear (no oscillator), reception can be restored to full volume and plenty of stations can be logged. Even then it will again gradually fade away in the space of 4 or 5 hrs. and can always be restored by realignment. The 6L7 tube was replaced, by someone, with a glass 6L7G tube, the only discrepancy I can locate.

(A.) The fading on your Sears, Roebuck & Co. receiver is a case of "oscillator drift." Replace the oscillator series condenser and realign the receiver completely.

DROP IN CAR-RADIO SIGNAL STRENGTH

(148) C. E. Hodgkinson, Lakeland, Florida.

(Q.) I have a Philco model 818 car-radio set which has me stumped. On a static test with ordinary instruments the coils, resistors, condensers, and voltages test OK.

Further, I can get a good, strong I.F. signal from the 6A7 grid right on through. Also, I can get a good, strong broadcast signal (any frequency between 550 and 1,500 kc.) right through.

But the rub comes in, when on disconnecting the signal generator, and connecting the regular car antenna the signals drop to almost nothing. With a regular house radio antenna connected signals come in pretty good.

(A.) Probably all that is necessary to relieve the apparent lack of "sensitivity" of your Philco model 818 auto receiver is to short-circuit the R.F. choke in the antenna circuit. Realign the R.F. circuits after this is done, with antenna to be used connected.

Please Say That You Saw It in RADIO-CRAFT

RECENT TEST EQUIPMENT

(Continued from page 459)

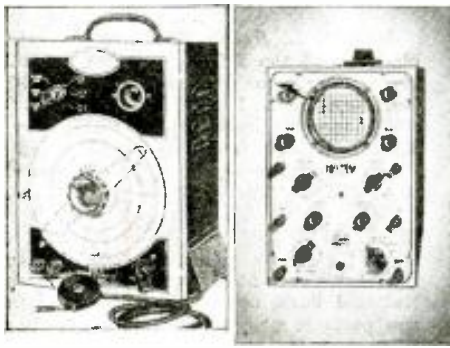

AEROVOX

TRIUMPH

switch, as follows: Range A, 60-170 kc.; B, 170-490 kc.; C, 490-1,500 kc.; D, 1.5-4.6 mc.; E, 4.5-15 mc.; and F, 13-26 mc. The frequency dial is directly calibrated in frequency for each of the 6 ranges, and calibration should be accurate to 1% or better. The shadow angle of a "tuning eye" type 6E5 tube is used to indicate the amount of energy in the oscillator circuit, and this angle widens when the oscillator is coupled to a tuned circuit of the same frequency as the oscillator. The dial is also calibrated in capacity from 400 mmf. to 1 mf. with an accuracy of $\pm 10\%$. Condensers below 400 mmf. may be read in several ways by the use of a coil or an additional condenser.

Coupling is accomplished by 2 methods: (1) The coupling link may be coupled inductively to the electromagnetic field of the coil in the tuned circuit; and,

(2) The terminals marked "Capacity Coupling" may be connected across a tuned circuit by means of short leads.

Frequency calibration of oscillator may be shifted down in frequency about 5% if the capacity-coupling terminals are shorted and the oscillator is set near the high-frequency end of the coil range. This condition represents the worst possible condition. In general, the shift in frequency may be disregarded when using link coupling, instead of the capacity-coupling probe.

Among the uses for the L-C checker are:

- (a) Alignment of R.F. circuits and tracking of oscillator of superheterodyne receiver.
- (b) Alignment of both broad and narrow-band I.F. amplifiers.
- (c) Tuning of wavetraps and image-rejection circuits.
- (d) Checking the frequency ranges of a receiver or signal generator, and for frequency calibration of wave-meters.
- (e) Identifying harmonics of a frequency standard in precision frequency calibration of radio equipment.
- (f) Checking natural resonant points of R.F. chokes to make certain they occur outside the range over which the chokes are expected to operate.
- (g) Tracing resonant absorption trouble in all-wave receiver circuits (locating dead spots, etc.).
- (h) Locating resonant points in shorted windings (unused coils in multi-range oscillators, etc.).
- (i) Locating resonant frequency of R.F. coupling chokes to make sure they are in the right place to secure enough gain balance over tuning range of R.F. stage.
- (j) Tuning very broad band filter circuits (as used in television I.F.'s).
- (k) Checking the natural period of antennas, especially receiving antennas and transmission coupling line systems designed to have resonant peaks at certain frequencies.

The L-C Checker has further uses, such as measuring capacity, and the effectiveness of R.F. bypass condensers without unsoldering them from circuit. Also measuring condensers in terms of standard inductances and, vice versa, measuring coils in terms of standard condensers; especially, with the 2-frequency method for very high accuracy. Coils may be accurately matched in production testing. Likewise condensers can be measured for capacity, R.F. resistance or inductiveness. With the aid of a vacuum-tube voltmeter and a calibrated condenser, the "Q" may be measured by reactance variation.

ODDITIES

CAT AND DOG CABLE TESTER!

The ability of a dog to locate a cat by smell alone was utilized by British radio engineers to locate leaks in the 16-mile-long gas-filled coaxial cable which is buried 3 feet underground and feeds into the new trans-Atlantic radiotelephone receiving station near Rochester, England. A gas smelling of cats was introduced into the tubing, and a Labrador retriever was taken along the route of the cable. Fourteen times the dog started digging, and each time a leak was found. This method eliminated digging up the entire cable.

(National Radio News)

MEASURES 0.0000001-VOLT!

The U.S. Bureau of Standards recently announced the development by Messrs. Teele and Schuhmann of a potentiometer capable of measuring 10 microvolts to an accuracy of 0.01-microvolt. To obtain the desired range and accuracy, special thermal shielding, reversing key, and 4-terminal resistor, as well as refinements of technique, were necessary. If you're interested, look up the Bureau's Journal of Research (RP1195).

Articles in FEBRUARY RADIO & TELEVISION

Hear WAR NEWS Direct! On 2-Tube "Overseas" DX-er. (A battery "All-Wave" Portable, using latest low-drain tubes.)

World-Wide Radio Digest
Building an Ore Locator that Works!
Extra Money for the HAM and SERVICE-MAN! How to build a S-W Diathermy Machine for your "local" doctor.—Allen Stuart.

Cathode-Modulated Transmitter for the HAM—Harry D. Hooton, W8KPX.
Recording Radio Programs at Home
Questions and Answers
World Short-Wave Station List
Big FOTO-CRAFT Section:

MONEY—From your Photos
Portraiture as a fine art—Ray Lee Jackson.

Strip-Printer; Microphotography, by Dr. E. Bade; Course in Photo Composition; Hints & Kinks; How to Photograph your Radio Set, and many other practical Photo features.

Why Take A Chance?



USE WRIGHT VERIFIED SPEAKERS

Catalogue mailed on request

WRIGHT, Inc.

2233 University Ave., St. Paul, Minn.

DATAPRINTS



TESLA-ODIN HI-FREQ. COILS

- 20c Ea. in order for 10 (Data and Drawings only.)
 - 36" Sp'k Tesla-Oudin Coil 40c (1 K.W. Exc. Trf. Data, included FREE!)
 - 8" Sp'k Tesla-Oudin Coil 40c (1/4 K.W. Exc. Trf. Data, included FREE!)
 - 3" Sp'k Oudin; 110 Vt. "Kick Coil" type.....40c
 - 3" Sp'k Tesla Works on Ford Sp'k Coil.....40c
 - 1" Sp'k Violetta Hi-Freq. Coil.....40c
- Model Warships—Get List of Plans



Induction PIPE & ORE LOCATOR

Construction Data40c

YOU need these DATAPRINTS!

- 5 Meter Superhet.
- 1/2 Meter Tr. & Rec. Bridge
- 20 A.C. Probs. & Ans. Weld. Transf. 2 K.W.
- 20 Telephone Hook-ups Rewinding Armatures
- 100 Mech. Movements String Galvanometer
- 20 Motor Hook-ups 20 Simple Bell Circuits

Special Prices: 4 prints \$1.00; 10 for \$2.00; Single, 40c each. Get New Catalog 100 A.

The DATAPRINT Co.
Lock Box 322C, Ramsey, N. J.

RADIO COURSES

New Classes Now Starting
RADIO OPERATING—BROADCASTING
● RADIO SERVICING — a practical course
● RADIO AMATEUR CODE ● TELEVISION
● ELECTRONICS—1 yr. day course 2 yrs. eve. Day and Evening Classes. Booklet Upon Request.
New York Y.M.C.A. Schools
4 W. 64th Street New York City

THE RADIO MONTH IN REVIEW

(Continued from page 493)

F.C.C.

The Federal Communications Commission, last month, granted RCA an extension of special temporary authority to operate general experimental station W3XDS on 950 kc., 1 kw., to conduct a comprehensive field survey of the effects of fading on amplitude-modulated signal.

First National Television, Inc., Kansas City, Mo., received an OK to switch W9XAL from telly on 43-56 and 60-86 mc. to 44-50 mc.

Imityr Hotovitzky, Belkofsky, Alaska, last month was granted a construction permit for a new fixed point-to-point telephone station, KADZ, on 1,540 kc., 50 W., to be used primarily for short-distance communication between non-government stations in Alaska in cases of emergency.

Last month Carman R. Runyon, Jr., Yonkers, N. Y., was granted permission to change the classification of developmental broadcast station W2XAG to high-frequency broadcast, and operate on 117.19 mc., 5 kw.

WCAU Broadcasting Co., Philadelphia, Pa., received an OK for a television station on 78 to 84 mc., 1 kw.

Radio Pictures, Inc., Long Island City, N. Y., last month applied for permission to transmit telly pics on 96-102 mc. instead of 42-56 and 60-86 mc.

W3XDS was granted permission to conduct a survey of the effects of fading on amplitude-modulated facsy on 950 kc., 1 kw.

The City of Boston Fire Department, Boston, Mass., last month applied for permission to operate 3 fire stations aboard fire boats on 33.74 mc., 50 W., in conjunction with station WEY.

Last month Farnsworth Television and Radio Corp., Fort Wayne, Ind., requested permission to build a telly station at 3700 E. Pontiac St., Fort Wayne (and to utilize the aural equipment of W3XPF, Springfield, Pa.) on 66-72 mc., 1 kw.

General Television Corp., Boston, Mass., requested permission to transmit telly on 44-50 mc. instead of 42-56 and 60-86 mc.

A telly station for Avon, Conn., was requested by The Travelers Broadcasting Service Corp. to operate on 84-90 mc. 1 kw. Same Co., same place, was given the OK to operate an F.M. station as W1XSO on 43.2 mc.

Albany, N. Y., now has a facsy station under construction on Central Ave. and Tremont St., by WOKO, Inc., for operation as W2XWE on 25.05 mc., 500 W.

John V. L. Hogan last month received blessings of the F.C.C. to switch his F.M. transmitter from Alpine, N. J., to 3104 Northern Blvd., Long Island City, N. Y., and change its frequency from 111.5 mc. to 43.2 mc. Also, permission was granted to change the frequency of H.F. broadcast station W2XQR from 41.2 mc. to 43.2 mc.

BROADCAST

In the series of broadcasts, "Nature Sketches," presented from Rocky Mountain National Park, and concluded a short time ago, portable microphones followed the party through fields and woods, picking up the voices of the group, while parabolic mikes on-location brought in a background of bird songs and sounds of the out-of-doors.

C.B.S. commentator H. V. Kaltenborn last month solved the problem of obtaining uninterrupted reception of a speech by Hitler (which was being interrupted, in its broadcast over WHAS, by English translations), upon which H.V.K. was soon to comment, by having the speech sent out by short wave from Riverhead, N. Y., to WHAS and there piped to Kaltenborn in a nearby private office.

The Radio Section of Variety last month reported that Mexico is still the hold-out on ratification of the pact for regulation of wavelengths in North America agreed upon by the various countries represented at the Havana Conference some time ago.

Columbia Broadcasting System last month leased the Ritz Theatre at 219 West 48 St., New York, N. Y., as "C.B.S. Theatre No. 4." It is expected this will bring C.B.S.'s audience accommodations to nearly 2,000,000 persons per year.

The result of the evaluation at the close on January 31 of the current semester of the educational value of school programs over WNYE, New York, will determine whether this station of the Board of Education should be closed down. The decision may influence educational radio stations throughout the U.S.

Coin phonographs are so popular in the "hinterlands," Variety reported last month, that the record choice of users tends to determine the music played on radio programs inasmuch as sponsors are now closely following the reports of coin-phono record sales!

Most powerful radio station on the North American continent is now XEW, Mexico City, which has upped its power to 200 kw.

Advertisements in Mexican papers now list program times and wavelengths of 27 German S-W. stations.

FACSY

W. G. H. Finch last month was granted patent No. 1,177,247 on a method of transmitting colored photographs over telephone wires. It is claimed that prints can be enlarged 4 times without losing detail.

Finch Telecommunications last month asked the S.E.C. for permission to sell 87 shares of common stock in their facsy business at \$1 par.

ELECTRONICS

An applause meter, read backwards by judges in a beauty contest at Birmingham, Ala., last month caused red faces.



Get This Electric Dry Shaver
ABSOLUTELY FREE
with a Year's Subscription
to RADIO-CRAFT!

JUST THINK OF IT—you can get absolutely FREE, the useful DRY ELECTRIC SHAVER which is shown at the left. This ELECTRIC DRY SHAVER is sent to you by the publishers with a one-year subscription to RADIO-CRAFT.

Here Are the Features of the ELECTRIC DRY SHAVER

Constructed of metal with attractive red bronze finish. Scientifically constructed to give a perfectly clean shave. 5-foot rubber insulated cord and plug. Constructed to last for many years.

Operates from 110-volt, 60-cycle A.C. electric line. Carries a two-year manufacturer's guarantee. A fine-quality, self-sharpening toilet necessity.

Send your subscription to RADIO-CRAFT for One Year (12 issues) and receive absolutely FREE one of these remarkable Electric Dry Shavers. New subscribers are accepted or you may extend your present subscription another twelve months. Mail your remittance of \$2.00 (plus 25c for shipping charges on Shaver) to the publishers. (Canada and foreign \$2.75.) You will receive your DRY ELECTRIC SHAVER immediately by return mail. Use coupon below to enter your subscription.

RADIO-CRAFT
99 Hudson Street, New York, N. Y.

RC-2-40

Gentlemen: Enclosed find my remittance of \$2.00 for which enter my subscription to RADIO-CRAFT for one year (12 issues). Send me immediately FREE ELECTRIC DRY SHAVER (Canada and foreign \$2.75). In U. S. add only 25c additional to cover shipping charges on Shaver.

New Subscriber Extend Present Subscription

Name

Address

City State

(Send remittance by check, money order or unused U.S. Postage Stamps. Register letter if you send cash or stamps.)

WE SHIP ELECTRIC DRY SHAVER THE SAME DAY YOUR SUBSCRIPTION ORDER IS RECEIVED.

CLIP COUPON— AND MAIL!

Please Say That You Saw It in RADIO-CRAFT

The approach of death as indicated by the darkening of blood was demonstrated last month, before the annual clinical congress of the American College of Surgeons, in Philadelphia, Pa., as being detectable by means of a photoelectric cell. Animals were used to detect this loss of oxygen by the blood. An exciter lamp projects a strong light through skin, a finger, for example, to determine its pallor.

Emil Skona, a Seattle electrician, has an electronic-equipped apartment in which the window closes, an electric heater snaps on, an alarm rings, a toaster starts functioning and a pot of coffee begins to gurgle, at arising time, the A.P. reported last month.

The Byrd Antarctic Mailbag, c/o the General Electric Company, Schenectady, N. Y., is the address for "mail" to be radioed to Admiral Byrd (who will have with him the radio-equipped "Bear of Oakland," and "North Star") during his forthcoming stay in Little America, via shortwave radio station WGEO on 31.48 mc. or 9.53 mc. Letters must be confined to 50 words or less.

DEATH RAYS

Dr. Antonio Longoria was reported last month to have accidentally discovered in 1921, at the Longoria Research Institute in Lakewood, near Cleveland, an actual death ray capable of killing pigeons within a distance of 4 miles. The device was reported to utilize certain rays which may be made to emanate from X-ray equipment.

RADIODYNAMICS

Details for a radio-controlled flying torpedo were disclosed to the War Department by U. A. Sanabria of American Television Institute, last month. "This torpedo has been successfully demonstrated," said Mr. Sanabria. (See the "Television Torpedo" by U. A. Sanabria, in the November 1938 issue of Radio and Television!)

Last month U.S. patent No. 2,176,469 was granted to Henri Moueix of Paris, for a projectile to be steered by radio. The projectile is described as carrying 2 shortwave transmitters and a receiver. One transmitter broadcasts dashes, the other dots. Over-lap of these transmissions forms a continuous note or beam which indicates that the projectile is headed for its objective; the beams sent out by the transmitters strike enemy craft, are reflected and, picked up by the receiver on the projectile, operate its controls to cause it to travel head-on to its objective.

Otto H. Mohr, Oakland, Calif., resident, was reported in the New York Times last month as having developed a "detonator ray" machine, utilizing solar energy, capable of setting-off rifle cartridges at a distance of about 2 miles. No means have been discovered for controlling the direction of the ray from this "solarmohr" which also is said to be capable of exploding gasoline tanks.

Dr. Lee DeForest last month described a television facsimile set-up of interest to the U.S. Army. The system is described as enabling a man in an observation plane to draw maps of strategic positions and targets and to transmit them back to headquarters by television.

Radio-Craft suggests that a television pick-up camera in an airplane could be used to instantaneously pick up the terrain below and radio it to telereceivers back at headquarters. The cathode-ray image at the receiver could be projected onto a 9x12 ft. wall, if desired!

The U.S. Army last month witnessed demonstrations, at its Aberdeen Proving Ground, of an unmanned tank which backed up 3,000 ft. and then under radio control headed for army anti-tank gun emplacements which blew the tank apart.

F.M.

Jansky and Bailey, Washington, D. C., last month were granted permission to conduct frequency-modulated tests on 43.2 mc., 1 kw., over station W3XO.

Don Lee Broadcasting System last month requested permission to construct a frequency-modulated relay broadcast station operating on 50 W. to feed signals on 133.03 mc., 134.85 mc., 136.81 mc. and 138.63 mc., in the area of KHJ, Calif.

North Sacramento, Calif., may break into the pioneer telly elite with a 1-kw. station, on 50-56 mc., on Grand Ave. at Elm Street, if the F.C. Commissioners grant the recent application of Grant Union High School District. Also, the application was amended to specify frequency-modulated link equipment.

The Bamberger Broadcasting Service last month received an OK from the F.C.C. to put W2XW1 on the air as a frequency-modulated station on 43.3 mc., 1,000 W., at Alpine, N. J.

Last month the F.C.C. granted special temporary authority to RCA Mfg. Co. in Camden, to make tests in frequency modulation over W3XEZ with 1 kw. on 42.6 mc.

Bell Telephone Labs. last month was granted permission to operate a pair of frequency-modulated transmitters with 20 W. on 38.8 mc. and a pair of amplitude-modulated transmitters with 15 W. on 38.8 mc., for comparative tests of frequency vs. amplitude modulation, for communication to and from airplanes and automobiles within 100 miles from N.Y.C. Call letters W10XJT, W10XJU, W10XJV and W10XJW. The F.M. station will be located atop the Empire State Building.

Portland Broadcasting System, Inc., Portland, Maine, last month applied for construction permit for a frequency-modulated station on 43.4 mc., 1 kw.

McNary and Chambers, Bethesda, Md., was granted permission to construct a frequency-modulated station on 42.6 mc., 100 W.

The Yankee Network, Inc., applied for a construction permit for a new frequency-modulated transmitter at North of Alpine, N. J., on 43 mc., 50 kw.

An OK was given to the Yankee Network for an F.M. station on the summit of Mount Washington, N. H., on 42.6 mc., 5 kw.

Zenith Radio Corp., Chicago, Ill., will go frequency modulation on 42.8 mc., 5 kw., at 6001 Dickens Ave., if the F.C.C. grants its application of last month.

Radio failed to save the life of radio operator Edward Gaynor of Montreal, who succumbed to the wilds of the lower St. Lawrence where the airplane, in which he and a pilot who also lost his life, came to grief.

Ray D. Scudder, script writer for N.B.C., last month lost his life in the I.R.T. subway in New York City.

FREE ... to 1000 Servicemen Only!

Act at once ... Get at no cost!

- (1) A Jumbo Screw Driver plus
- (2) Expert Analysis of Your Shop plus
- (3) The Approval Certificate

A great new WEBBER service to radiomen! We want you to plan your shop far in advance—thus getting the most for every dollar spent on test equipment.

To make this help doubly attractive, we will, for a limited time only, give you a jumbo screw driver, with heavy handle and case hardened blade—at absolutely no cost—if you will fill out and return to us a simple shop analysis blank.

When this is received, The WEBBER Serviceman Advisory Council, composed of outstanding service authorities, will study your problems, and write a complete program for equipping your shop to meet every need of modern servicing.

Get the APPROVAL CERTIFICATE

To every Serviceman whose shop meets standards prescribed by this experienced committee for servicing all 1940 receivers—will be awarded a large 12" x 9" two color display certificate attesting to his ability to give set owners accurate and dependable service.

Act Now! Take advantage of this big plan to help you in your work. It is the WEBBER way of building Serviceman good-will.



Dynamic Tube Tester.....\$29.95

A real dynamic instrument reading GOOD or BAD on large 3 1/2" meter. Tests for dynamic mutual conductance, power output and emission. Filament voltages from 1/4 volt to 117 volts. Catalog lists sixteen other tube testers.

FREE THIS JUMBO SCREW DRIVER

Just clip and mail the coupon shown below to get this handy screw driver, which retails for as much as fifty cents—as well as an analysis of your shop to help you plan for the future.

MAIL TODAY!



Send at once, with no obligation to me, the new WEBBER Shop Analysis, which entitles me to the FREE Jumbo Screw Driver, and an approval certificate for my shop.

Name

Address

Please Say That You Saw It in RADIO-CRAFT

OPPORTUNITY AD-LETS

Advertisements in this section cost five cents a word for each insertion. Name, address and initials must be included at the above rate. Cash should accompany all classified advertisements unless placed by an accredited advertising agency. No advertisement for less than ten words accepted. Ten percent discount for six issues, twenty percent for twelve issues. Objectionable or misleading advertisements not accepted. Advertisements for March, 1940, issue must reach us not later than January 6th.

Radio-Craft • 99 Hudson St. • New York, N. Y.

AGENTS WANTED

300% PROFIT SELLING GOLD LEAF LETTERS FOR store windows; Free samples. Metallic Company, 451 North Clark, Chicago.

BOOKS AND MAGAZINES

ASSURE YOURSELF OF GREATER PROFITS by doing radio service jobs more quickly. Authentic service guides show you the way to locate and correct troubles in any radio receiver. Kernback Official Radio Service Manuals show you how to complete more repair jobs in less time—how to earn more money by faster servicing. Turn to page 497 and learn how you can get Manuals on a free inspection plan.

WE HAVE A FEW HUNDRED RADIO ENCYCLOPEDIAS, by S. Gernsback, second edition, originally sold at \$3.98. Book has 352 pages, weight 3 lbs., size 9 x 12 inches. Red morocco—keratol flexible binding. Send \$2.49 in stamps, cash or money order and book will be forwarded express collect. Techifax, 1915 So. State Street, Chicago, Illinois.

TELEVISION EXPLAINED—LARGE 11" x 14" BROCHURE, printed in two colors, replete with diagrams and photos, explains television broadcasting. Invaluable for the amateur or engineer. \$1.00. RCA Manufacturing Company, Camden, N. J., Box TB-3895.

"RADIO WORLD" MAGAZINE BACK ISSUES wanted. Give details. Beltman, 3727 West 13th, Chicago.

BUSINESS OPPORTUNITY

WANTED: FINANCIAL BACKER TO FINANCE models and patents on practical inventions. Paul Brassard, 16 Cumberland Street, Brunswick, Maine.

CAMERAS & SUPPLIES

BULK FILM: 100 FT. 8MM. \$90; DOUBLE. \$1.60; 16 mm., \$1.20. Titles or Pictures, chemicals, outfits. Big catalogue for stamp. Hollywood Studios, South Gate, Calif.

DIATHERMY (SHORT-WAVE THERAPY) MACHINES

DIATHERMY, SHORT-WAVE THERAPY, AND ultra short-wave therapy machines custom-built by radio engineer at considerable saving over commercial machines; 6 meters, 16 meters or any other frequency specified can be furnished. Machines substantially built with high Patient-safety factor. 250-300 watts output. Neat professional appearance. Automatic safety time switches. All necessary pads and electrodes. For sale only to physicians, hospitals and sanitariums. Prices from \$195.00 to \$300.00. Not for sale to the general public. Write for further information giving your own specifications and requirements. Allan Stuart, 1015 Wilson Ave., Teaneck, N. J.

EDUCATIONAL COURSES

USED CORRESPONDENCE COURSES AND EDUCATIONAL books bought, sold, rented, exchanged, all subjects guaranteed. Catalog Free. V. W. Vernon, Henagar, Alabama.

CORRESPONDENCE COURSES AND EDUCATIONAL books, slightly used. Sold. Rented. Exchanged. All subjects. Satisfaction guaranteed. Cash paid for used courses. Complete details and bargain catalog FREE. Send name Nelson Company, B-242 Manhattan Building, Chicago.

FOR INVENTORS

CASH FOR UNPATENTED IDEAS. STAMP APPRECIATED. Mr. Bull, 9411-J Pleasant, Chicago.

MISCELLANEOUS

110-VOLT A.C. BALL BEARING GENERATORS FOR Auto P.A. etc. \$5.00. Standard Motor Service, Kenan, Wisconsin.

WANTED: OBSOLETE STOCKS AND BONDS. Brooks, Box 211, Malden, Mass.

RADIO

RADIO KITS—\$3.95 UP. COMPLETE. SINGLE BAND; all-wave; 5-10 tubes. Save 50%. Paris catalog—FREE. McGee Radio, P-2035, K.C., Mo.

WE BUY AND SELL USED RADIO TESTING EQUIPMENT. Time payments if desired. Harold Davis, Inc., Jackson, Miss.

ANY RADIO DIAGRAM. 25c. SPECIFY MANUFACTURER, model. Radio magazine free. Suburban Publications, 3727 West 13th, Chicago.

SEND 25c TODAY FOR C.A. AUSTIN'S BOOKLET "Recording for Pleasure or Profit." Build it yourself Recorder, setting up low cost studios and studio procedure fully covered. Speak-O-Phone Recording & Equipment Co., 23 West 60th St., New York, N. Y.

START NOW BUILD RADIOS. AMPLIFIERS, ETC., from our plans, ten circuits, ten centers. Long, 111 N. Enterprise, Bowling Green, Ohio.

THE "PERFECT GLASS"

ARTIFICIAL growth of large and optically perfect lithium fluoride crystals, which, because they transmit light over a wider range of wavelengths than any known optical material, hold promise of extending the horizon of atomic research, was recently announced by the Department of Physics of the Massachusetts Institute of Technology.

The ability of lithium fluoride crystals to transmit light far exceeds the range of natural quartz crystals, fused quartz, the best optical glass, and rock salt crystals, all of which fail to transmit any but the longer waves in the ultraviolet region of the spectrum. *Lithium fluoride crystals transmit light waves from high in the infrared region through the visible band and deeper into the invisible ultraviolet wave region than any known substance.*

Lithium fluoride promises to have important uses even for light of the visible range, because it refracts the different colors of light far more nearly equally than does any other known substance. For this reason, lenses of the material are less subject to chromatic aberration which, with glass or quartz, makes necessary the use of compound lenses in order that the optical images of an object in one colored light may not be blurred, while those in another colored light are sharp.

In its application as a new tool of science, the lithium fluoride crystal is expected to play an important role in spectroscopic investigations. The crystals may also be an important contribution in the field of microscopy—and television.



Here Professor Stockbarger is shown removing a 3-inch crystal of lithium fluoride from the thin platinum crucible in which it was artificially-grown at a temperature of more than 1,200° Centigrade. Before him are other crystals of various sizes. The electric furnace in which they were grown is shown at the right. Next step is cutting and polishing the crystals.

OPERATING NOTE

A.C.-D.C. AND 32-VOLT SETS

Unless the Serviceman uses the proper current rating dial light a new ballast will not help him much, as witness the following:

On many A.C.-D.C. sets and also 32-volt Delco radio receivers the dial lights are usually wired in parallel to the line voltage dropping resistor or in some instances to a section of it. As a rule these dial lights are 6.3-volt, 0.25-A., and if bulbs rated at 6.3-volt, 0.15-A. are substituted they will either burn out immediately or last only a short time. We always carry a supply of both kinds as to use the heavy-current types for small A.C. radio sets would tend to overload the filament windings of the transformers since small radio receivers have as many as 3 dial lights.

J. F. BROOKS,
Rome, Georgia.

Please Say That You Saw It in RADIO-CRAFT

FREE- REAL ELECTROPLATING OUTFIT



Now—
You Can **ELECTROPLATE**
EASILY WITH A BRUSH

SOMETHING new for radio men—something which gives you the opportunity to make additional profits—or to improve your type of service. Here's an **ELECTROPLATING KIT** amazingly simple to operate—you just Electroplate with a Brush!

NOT A TOY!

Electroplate for profit, hundreds of things in the household—ashtrays, fixtures, water faucets, worn brackets, door knobs, musical instruments, jewelry and silverware and other articles. It's an indispensable piece of equipment—plate articles in hotels, apartments, office buildings, medical and dental offices, factories, schools, laboratories, etc. Exactly the same outfit (but larger) is used professionally by electricians, radio service men, automobile repair shops, etc. Requires one single dry cell 1½ volt battery to operate.

You can electroplate tarnished receiver parts, earbuds, contacts, worn radio parts and accessories, and display chassis. Put this **REAL ELECTROPLATING KIT** to use immediately—make it the most useful article in your shop or laboratory. And you can get it absolutely **FREE** (except for slight mailing cost).

Subscribe today to **RADIO-CRAFT** for One Year (12 issues) and receive absolutely **FREE** this **ELECTROPLATING KIT**. New subscribers are accepted or extend your present subscription twelve months. Mail remittance of \$2.00 (plus 10c for shipping charge on kit) to the publishers, (Canada and foreign \$2.85). You will receive your **FREE, REAL ELECTROPLATING OUTFIT** by return mail. Use coupon below to enter subscription.

RADIO-CRAFT

99 Hudson Street

New York, N. Y.

RADIO-CRAFT

RC-240

99 Hudson Street, New York, N. Y.

Gentlemen: Enclosed find my remittance of \$2.00 for which enter my subscription to **RADIO-CRAFT** for One Year (12 issues). Send me **FREE, REAL ELECTROPLATING OUTFIT** (Canada and foreign \$2.85). In U. S. add only 10c additional to cover shipping charges on kit.

New Subscriber Extend Present Subscription

Name

Address

City State

(Send remittance by check, money order or unused U. S. Postage stamp. Register letter if you send cash or stamps.)

OPERATING NOTES

RCA 101 AUTO-RADIO

Here is a time-saver on an RCA set. After removing the set from the dash panel, and without disconnecting any wires, remove speaker cover and check the connections and the soldering job. The speaker case is sometimes put on too close and therefore the speaker touches the center-tap of the volume control, whereupon the speaker goes "dead" — as far as signal is concerned.

Remedy: remove the cover, and if signal returns after tuning, resolder lugs and tighten speaker screws. Then tape center-tap and replace speaker cover.

ARTHUR M. HORATER,
Bridgeport, Conn.

FADA MODEL F52

To eliminate oscillation at the lower frequencies, in an F52, add a 10,000-ohm resistor across the primary of the antenna coil (marked in red on diagram).

condensers for shorts due to breakage of the mica.

MAJESTIC 200 SERIES

Weak reception in the case of a "200" of this make may be due to the breakdown of the voltage divider.

FORD 40 & 18805 "GLOVEBOX"

Weak reception in a "glovebox", with the transformer getting hot but fuse refusing to blow, usually calls for replacing a partly-shorted buffer condenser with a unit rated at 0.0125-mf. 1600 V.

BILL ESLICK,
Norwich, Kans.

MAJESTIC "CHARLEY McCARTHY"

The complaints were "intermittent reception," "reception fading out, accompanied by a crackling noise."

These troubles were traced to a poorly-

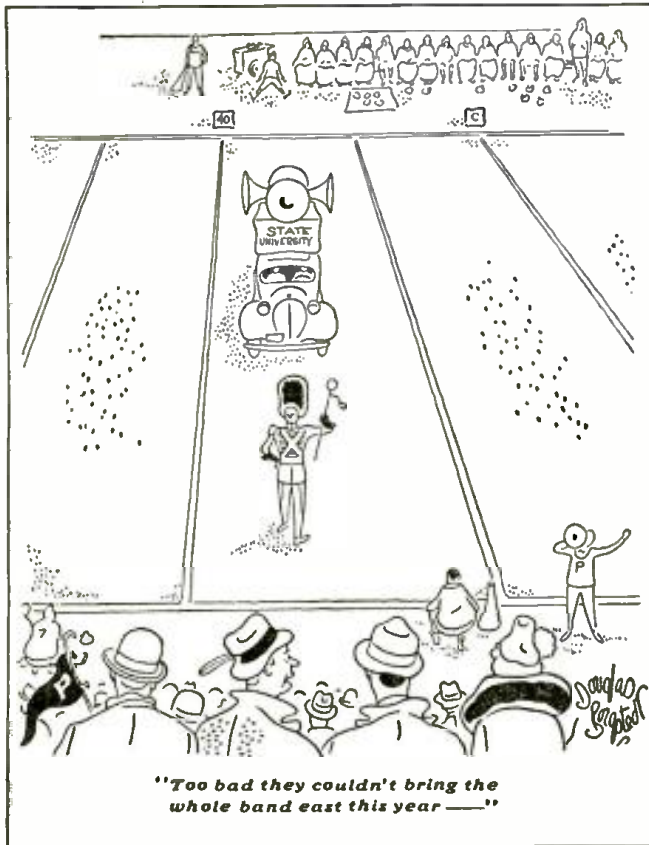

Reproduced by special permission of *The Saturday Evening Post*, copyright, 1937, by the Curtis Publishing Co.

FADA L56

To increase antenna pick-up by this set add a 0.01-mf. paper condenser (part No. 10.10) from lug (black lead on loop) to chassis ground (marked in red on factory service diagram).

FADA 61-69 PHONO COMBINATION

If the complaint is "hum," upon making a service call on this model, look for A. C. leads from ballast to rectifier (blue-brown) which are too close to the grid of the 6SQ7GT. Lift and rearrange on opposite side of chassis.

L. GALANEK,
Fada Radio & Electric Co.

ATWATER KENT 84, 84F

A weak or dead A.K. of this series calls for a check of the trimmers on the gang

soldered or high-resistance connection to the grid cap of the 6Q7 tube.

I have found this trouble on several mid-get radio sets using the G T tubes; others are Fada and Emerson.

BYRUM HUDDLESTON,
Huddleston's Radio Service,
De Leon, Texas.

RADIO RODENTIA—ALL SETS

If the complaint is "squeaks, peeps and whistles," bait a small mouse trap, place it on the warmest (not hottest) part of the chassis and tell the customer to return the set in a week. You then merely remove the "trouble" and throw it down the nearest sewer. Had such a case the other day. He was a cute little fellow.

Service man Sam

Please Say That You Saw It in RADIO-CRAFT

FREE

HANDSOMELY BOUND CAPACITOR MANUAL FOR RADIO SERVICING

Contains all latest information on servicing defective capacitors, including circuits shown in new Rider Vol. X. More than 240 pages, carefully catalogued for quick, easy reference. Everything you need to know about capacitor selection for replacement in all existing types of receivers. Result of many months painstaking research, Cornell-Dubilier's new "Capacitor Manual for Radio Servicing" saves hours of tiresome, non-profit labor. Compact—easy to carry around—it fits the coat pocket. A handsome addition to any serviceman's library. Get your copy free from your local C.D. distributor, or use convenient coupon below.

CORNELL-DUBILIER ELECTRIC CORPORATION
1014 Hamilton Boulevard, South Plainfield, New Jersey
Daily Address CDB02

Cornell Dubilier Electric Corp. Ac 240
1014 Hamilton Blvd.,
South Plainfield, New Jersey
Please send me a FREE copy of the new "Capacitor Manual for Radio Servicing".

NAME
ADDRESS
CITY STATE
MAIL COUPON ON PENNY POSTCARD

EASY — SIMPLIFIED — PRACTICAL

ELEMENTARY MATHEMATICS

HERE is a book for the business man, the technician and craftsman explaining and answering every operation and meaning with interpreting illustrations and examples. It is the key to a simple understanding of many perplexing problems in daily life. In clear, positive and definite language, the author popularizes and clarifies every subject and helps the reader to overcome any apparent difficulty in the study of mathematics. A real home study-course in mathematics for the student or the man who wants to achieve proficiency or desires to brush-up on his knowledge.

Entire Chapter on Special Mathematics for the Radio Technician

SEND TODAY FOR YOUR COPY OF THIS INDISPENSABLE BOOK. "PRACTICAL MATHEMATICS" CAN BE CARRIED READILY IN YOUR POCKET.

CONTENTS OF BOOK

CHAPTER I. Arithmetic—Addition—Subtraction—Multiplication—Division.

CHAPTER II. Factoring and Cancellation—Fractions—Decimals—Ratio—Proportion.

CHAPTER III. The Metric System.

CHAPTER IV. How to Measure Surfaces and Capacity (Geometry).

CHAPTER V. Powers and Involutions—Roots and Evolutions.

CHAPTER VI. Mathematics for the Manual and Technical Craftsman—Thermometer conversions—Graphs or Curve Plotting—Logarithms—Use of the Slide Rule.

CHAPTER VII. Special Mathematics for the Radio Technician.

CHAPTER VIII. Commercial Calculations—Interests—Discounts—Short Cut Arithmetic.

CHAPTER IX. Weights and Measures—Useful Tables.

ONLY **50c** POSTPAID

TECHNIFAX

RC-240
1917 S. State St. Chicago, Ill.

NEW BULLETIN
Describing The Latest **DIRECT-COUPLED AMPLIFIERS**
Designed By A. C. Shaney

No wide-awake public address technician or serviceman can afford to be without this literature, which covers the latest development in the audio field. Send for Your Free Copy Today. Ask for Bulletin No. 4000

AMPLIFIER CO. OF AMERICA
17 WEST 20th STREET NEW YORK, N. Y.

PRICED FOR CLEARANCE!

Rockbottom Prices on Overstocked New and Rebuilt Merchandise

When prices are low we buy! They're low now—LOWER THAN THEY EVER WILL BE—hence this sale. Most of the merchandise is new—never used; some of it reconditioned. 100% satisfaction on each transaction or your money refunded. ORDER FROM THIS PAGE. Use the convenient coupon below. Be sure to include sufficient extra remittance for parcel post charges, else the order will be shipped express, charges collect. Any excess will be refunded. C.O.D. shipments require a 20% deposit. If full remittance accompanies order deduct 2% discount. Send money order—certified check—new U. S. stamps. No C.O.D. to foreign countries.

ORDER TODAY QUANTITIES LIMITED PROMPT SHIPMENTS ASSURED

COMPLETE ELECTRIC SPRAYER OUTFIT



Consists of a sturdy compressor 110 V. 1/4 HP. 1750 RPM Motor. 10 ft. hose. efficient spraying gun and all necessary mounting accessories. Costs only 2 cents per hour to operate. Delivers considerable air pressure. Positively will not pump oil. Few working parts to wear. Sprays practically anything. Ship. Wt. 40 lbs.

ITEM NO. 46
Kit less motor, but with gun
Your Price **\$6.36**

ITEM NO. 47
The complete kit including 1/4 HP motor
Your Price **\$14.53**

WESTINGHOUSE WATTHOUR METER

Completely overhauled and ready for immediate service. Designed for regular 110-volt, 50 cycle 2-wire A.C. circuit. Servicemen use it in their shops to check current consumption of sets, soldering irons, etc. Keeps costs down. If dismantled, the parts alone would bring the price. The elaborate gear train could be used as a counter on machines of various kinds. Simple to install; 2 wires from the line and 2 wires to the load. Sturdily constructed in heavy metal case. Size: 8 1/2" high, 6 1/4" wide, 5" deep, overall. Ship. Wt. 14 lbs.



ITEM NO. 33
Your Price **\$4.50**

PORTABLE TELEGRAPH AND BUZZER FIELD SETS



Made for military use by Western Electric. A wonderful buy if only for the parts it contains. Never been used. Good for code practicing, signaling, communications, etc. Contains 2-tone, high-frequency buzzer with platinum contacts, telegraph key, telephone switches, earphone, condensers, transformers, chokes, etc. A \$20 value easily. Complete in wooden case with diagrams and instructions. Ship. Wt. 12 lbs.

ITEM NO. 16
Your Price **\$5.45**

SPERRY GYROSCOPE LIQUID COMPASS

Made for U.S. Signal Corps; sensitive and accurate. Quick readings easily made from top; accurate readings of graduations through focusing magnifying lens on side of instrument. Complete with level sights and russet leather carrying case. Excellent for boats, boy scouts, campers, hikers, etc. A few turns of wire around its case makes it usable as a galvanometer. Ship. Wt. 3 lbs.



ITEM NO. 12
Your Price **\$1.85**

WELDING! BRAZING! SOLDERING! 3-IN-1 PORTABLE ELECTRIC TORCH

WORKS FROM 110 VOLTS A.C. OR D.C. LINE

This electric torch is not a kiddy or a toy but a sturdily built outfit using the finest materials with which you are able to do professional type of welding, brazing and soldering work. Regardless of whether or not you've had previous experience, it will do a thousand and one jobs: tinner welding, auto body repairs, bumpers, cylinders, tanks and industrial repairs—ideal for steel fitters, plumbers, sheet metal jobs, engineers, maintenance men, radio and bicycle repair men, etc. Works on aluminum, brass, copper, iron, steel and other metals.

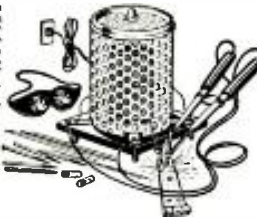

The 3-in-1 electric torch is so simply constructed that even a boy can operate it after reading the simple and concise instructions furnished with the unit. Not necessary to know how to strike an arc! All you do is plug the torch into the light socket, adjust the intense, blazing flame, ready for work. The outfit comes complete with power unit, electric cord, electrode holder, goggles, and instructions. Save money! Do your own repairing. Earn money by doing repairing for others. Simple, practical, durable and safe to handle—that's why the price is amazingly low. Don't delay—order one today. Ship. Wt., 8 lbs.

ITEM NO. 50
Your Price **\$6.95**

U. S. NAVY BAUSCH & LOMB TELESCOPE



Precision-built for U. S. Navy use as finders on large calibre guns. CAMERA FANS!—Use IT FOR CLIPPING UP OF DISTANT PICTURES. Optical system comprises 7 lenses on an erector and eyepiece draw tubes. Object lens 2" variable; eye lens 1 1/16" exit pupil 0.2" to 0.09"; Angular field 3°30'; power 3 to 10; erect image; cross hairs used. Net wt. 8 lbs. Original cost said to be over \$150. Ship. wt. 10 lbs.

ITEM NO. 25
Your Price **\$14.95**

TELEGRAPHIC TAPE RECORDER



A wonderful buy! Apparatus makes a written record of code and similar messages on paper tape. An ideal machine for learning code or teaching code to groups. Radio men can easily adapt it to short-wave receivers for taking permanent records of code messages. Double pen permits simultaneous recording of two messages. Pens are operated by battery and key white tape feeder is spring driven (hand wound). Case made of solid brass on heavy iron base. Completely reconditioned. (Less tape; easily obtained anywhere.) Original cost \$85.00. Ship. Wt. 20 lbs.

ITEM NO. 20
Your Price **\$19.95**

VARIABLE SPEED UNIVERSAL MOTOR

FOR 110 VOLTS, A.C. OR D.C.



Made for Dictaphone machines by American Gramophone Co. Used, but in excellent condition. Special lever control permits variable speeds up to 3000 r.p.m. 1/2" shaft extends from both sides of motor. Measure 7 1/2" x 3 1/4" diam. overall. Ship. Wt. 6 3/4 lbs.

ITEM NO. 51
Your Price **\$2.55**

WE HAVE NO CATALOG. ORDER FROM THIS PAGE.

HUDSON SPECIALTIES CO. - 40-R West Broadway - N. Y. C.

IT'S EASY TO ORDER—CLIP COUPON—MAIL NOW

HUDSON SPECIALTIES CO., 40-R West Broadway, New York, N. Y. RC-240

I have circled below the numbers of the items I'm ordering. My full remittance of \$..... (include shipping charges) is enclosed.

OR my deposit of \$..... is enclosed (20% required), ship order C.O.D. for balance. (New U.S. stamps, check or money order accepted.)

Circle Item No. wanted: 11 12 16 20 25 33 46 47 50

Name Address

City State

Send remittance by check, stamps or money order; register letter if you send cash or stamps.

RADIO HAPPENINGS IN BRIEF

"The Radio Furnace" is the title Robert (Believe It or Not) Ripley recently gave one of his illustrations. It seems that the furnace in the Henry Phillips home, Victor, N. Y., gives off speech, unaided by radio equipment, from station WHAM. In answer to an inquiry by *Radio-Craft* as to what might have caused this phenomenon (due mainly to the close proximity of WHAM's transmitter), the technical supervisor of WHAM recently advanced the following ingenious explanation.

"The audio modulation as near as we can determine is caused by a strong R.F. pick-up on the furnace smoke pipe. The joints in this pipe are coated with carbon dust which lets small arcs take place. These singing arcs vibrate the pipes and give off the sound. On one occasion when wood was burned the arcs disappeared but came back again as soon as coal was used."

The League of American Writers recently announced it has included 2 courses in *radio script writing* in its schedule of courses for the 5th term of the Writers' School.

In case you want to sell a radio set or an automatic phonograph to your local dairy farm it may be well to lend an ear to what dairyman L. R. Richardson has to say after 2 years of experiments with radio music.

Better milk and more of it, seems to result when our bovine friends get the *right kind* of music. Neither classical nor jitterbug music will do—it must be the fast and gentle tones of reels, old-time music, folk songs and popular music that doesn't lean too heavily on the brass. This Radio Dairy business of Richardson really is a moneymaker, inasmuch as the radio programs wrought such successful results that in place of the original restless cow he now has a herd of 30 contented ones.

Long-distance lovemaking was instituted not long ago when Sonja Henie and Tyrone Power played a love scene from their latest talkie, Irving Berlin's "Second Fiddle," for an international radio broadcast. Over more than 7,000 miles of land and sea, Sonja's voice from Oslo, Norway, was cut into the program, while Tyrone Power was switched-in from 20th-Century Fox in Hollywood, to re-enact one of the scenes.

It was reported recently in a magazine that a Dr. George Walker of the University of Kansas, School of Medicine, had devised a new kind of electrocardiograph (more correctly, a 'scope, since no graphic record is made) using television principles and employing a cathode-ray tube which would enable doctors to see the record of the patient's heart action instantaneously without waiting as is now necessary for a photographic film (graphic record) to be developed.

Actually, an electrocardioscope employing a cathode-ray tube was in daily use at the New York World's Fair.

FACSIMILE

Said a Bamberger Broadcasting Service release recently, "WOR looks back smugly on 12 months of *uninterrupted* experimentation in facsimile—the transmission of printed matter and pictures over the air

Please Say That You Saw It in RADIO-CRAFT

SERVICE AIDS FOR THE NEAR FUTURE

We predict that in the not too distant future, jeweler's forceps, magnifying glasses and pliers will become part of every Serviceman's tool kit—this in view of the new lilliputian tubes, sockets, permeability tuning units and the like, which have recently come on the market and which indicate one trend of future radio receiver components. Better get your eyes examined now, boys!

right into your own home." Transmissions are now made with both the Finch and RCA methods, using WOR on 710 kc., and the ultra-high-frequency station, W2XUP on 25.7 mc., every night after WOR's regular sound programs. Several hundred experimental receivers surrounding New York have been receiving perfect pictures, during this time, even up to distances of 100 miles. Now you know what that early-morning-hour "peep-swish, peep-swish" over WOR is all about. . . if you didn't already know.

The Buffalo Evening News . . . reported not long ago that it is now regularly broadcasting a miniature newspaper for facsimile reproduction in the home. Its present size is 3 pages 8 x 11 inches although the number of pages will be increased as the experiment develops. The News' private wire services, staff correspondents and local staff supply the news for the radio edition, which at present is printed between 1 and 2 A.M., 5 days a week, on 900 kc., over WBEN. Plan is, however, to deliver facsimile service on an experimental basis on an ultra-high frequency; under F.C.C. rulings this will make day-time operation possible. A standard RCA facsimile set-up is used. Following the initial part of this service, more serious attention will be paid to news service so that a careful study may be made of the need or desire for such a service to supplement radio news bulletins.

It is a mistaken idea, said the report, to assume that these facsimile papers will take the place of or compete with newspapers because, with the present equipment, it is only possible to publish a 3-foot strip of news or picture material in an hour. However, by all-night operation it is possible to deliver enough reading matter to give a very comprehensive summary and report of news developments.

Shortwaves and ultra-shortwaves hold great promise for aviation, stated Lloyd Espenschied recently in a talk before the Institute of the Aeronautical Sciences at

their annual meeting held in Columbia University.

The properties of these higher frequency waves that make them promising for aviation purposes, he stated, are:

Their limited range of transmission, up to about 100 miles, which is really of as much advantage as disadvantage since it enables a wave to be repeated in its use in a not too distant territory.

High stability of transmission within this range, and relative freedom from atmospheric disturbances.

A greatly increased intelligence-carrying capacity as compared with lower frequency bands.

Small transmitting and receiving antennas and the ability with which these waves may be concentrated in desired directions by means of directive antennas.

Italian patent No. 494,263 was granted not long ago to Marconi's Wireless Telegraph Co., Ltd., for a so-called directive wireless signaling system in which is indicated on a 360-degree scale, on the end of a cathode-ray tube, the direction from which a signal is being received. The system may be used with the rotating goniometer of a Bellini-Tosi or Adecock system, combined with an open aerial to eliminate the 180-degree ambiguity.

KINK

686 AS METER RECTIFIER. I have been a very interested reader of Radio-Craft magazine for quite some time, but I have never seen any data on the use of a 6H6 metal tube as a meter rectifier in test equipment. I have been experimenting with this tube for a short time and find it very satisfactory. So I am sending the hook-up (below) I use. It may prove interesting to some of your readers.

LAWRENCE L. BURCH

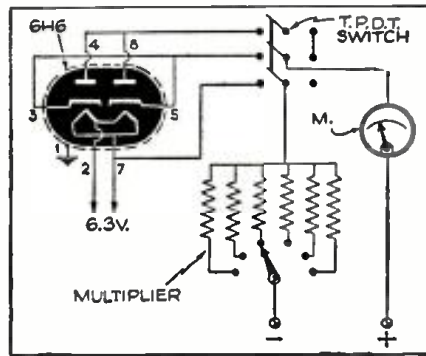

CORRECTION

Referring to the diagram on pg. 395 of the January, 1940 issue of Radio-Craft—

"Frequency-Modulation Programs on Your Present Receiver," by Glenn H. Browning and F. J. Gaffney—

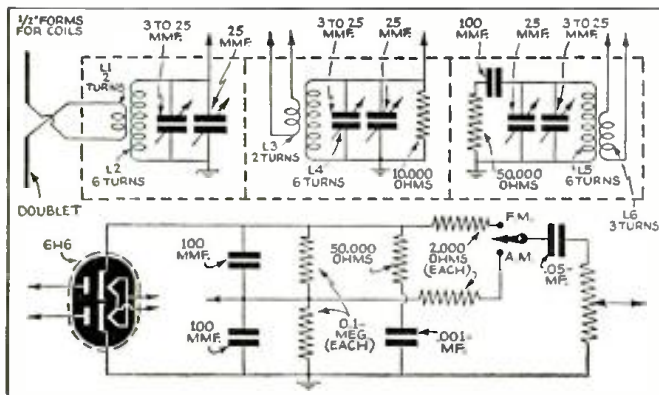

it will be observed that several values were not included in the high-frequency tuner assembly, L1. These values are shown in the diagram reproduced here. Also included are coil data. Note however that this assembly in order to be sufficiently precise in its final alignment requires the use of test equipment which ordinarily is not available to Servicemen.

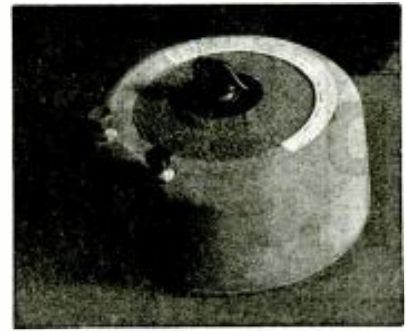

Model TBUR3
Size 6 1/2" diameter, 3" high

If it's a Talk-Bak* It's Wright-DeCoster

With ALL the latest improvements Wright-DeCoster Talk-Bak* units have become universally recognized as the finest equipment made for inter-communication systems.

Combining simplified installation, good appearance, excellent operation, and extremely long life (without service costs), Talk-Bak* units fulfill practically every operating need in inter-communication work.

Write for Talk-Bak* literature and catalog—include your distributor's name. Wright-DeCoster distributors are always anxious to cooperate.

WRIGHT-DECOSTER, Inc.

2251 University Ave., St. Paul, Minn.
Export Dept.: M. Simons & Son Co., New York
Cable Address: "Simontrice"
Canadian Representatives:
Wm. F. Kelly Co., 1207 Bay St., Toronto, Ontario
Taylor & Pearson, Ltd., Edmonton, Alberta

*Copyrighted.

Size of box: 12 1/2" x 8 1/2"

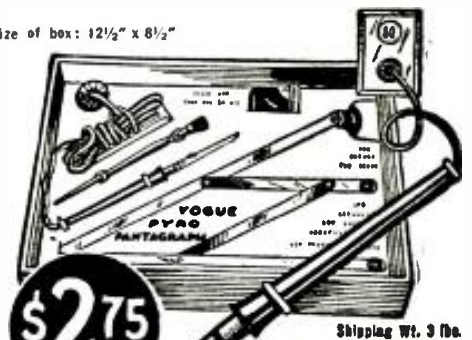

Pyro Pantagraph

With this PYRO PANTAGRAPH turn leisure time into profitable hours. Make money a novel, easy way—"Burn Your Way to Extra Dollars with Pyro Pantagraph." This electrical outfit is especially designed for burning designs permanently on Leather, Wood, Crk. Gourds, Bakelite, etc. Simply plug the Pyro-electric pencil in any 110-volt AC or DC outlet and it is ready to be used. Plug and cord furnished as part of equipment.

By the use of a special Pantagraph included in the outfit, any design may be reproduced either in original, reduced or enlarged form. Outfit consists of: one Pyro-electric Pencil; one Pantagraph; three hardwood plaques; one bottle of Varnish; one Brush; one tracing tip and four-page instruction sheet.

Outfit will be forwarded by Express Collect if not sufficient postage included with your order.

WELLWORTH TRADING COMPANY

1915 SO. STATE ST., Dept. RC-240, Chicago, Ill.

Please Say That You Saw It in RADIO-CRAFT

Order your copy NOW—the only P. A. HANDBOOK



**ONLY
25
CENTS
A COPY**

**MOST COMPLETE
AND AUTHENTIC
P. A. BOOK PUBLISHED**

THAT no book has yet been published which covers amplifiers and sound systems (also kindred systems), in one complete, authentic volume is almost unbelievable. Yet, it is a fact, there is no book in print which covers Public Address from A to Z. To bridge this widespread gap, RADIO-CRAFT will publish a complete, magnificent volume on Public Address of such magnitude—so complete and authoritative—that every man engaged in radio can have both a theoretical and practical knowledge of the function and operation of sound systems. The editorial pages are so filled with instruction and replete with illustrations that the volume fully justifies its title—1939-40 AMPLIFIER HANDBOOK AND PUBLIC ADDRESS GUIDE. This great HANDBOOK on Public Address should be read and studied by those who consistently build, service and sell sound equipment.

A MATCHLESS VOLUME

As complete as you would expect to find any engineering handbook—this is how the radio or P. A. man finds the **AMPLIFIER HANDBOOK AND PUBLIC ADDRESS GUIDE**. With essential technical data compiled from an exceptionally large number of sources, the volume covers nearly two hundred different subjects coordinating every conceivable branch or subdivision of Public Address.

THE CONTENTS

To actually show the scope and magnitude of the **AMPLIFIER HANDBOOK AND PUBLIC ADDRESS GUIDE**, an analysis of the contents is found at the right, showing the breakdown of the material featured within each particular section. A thorough reading of the contents shows the completeness of this book.

RADCRAFT PUBLICATIONS ■ 99 HUDSON STREET ■ NEW YORK, N. Y.

RADCRAFT PUBLICATIONS, INC. ★ 99 HUDSON STREET ★ NEW YORK, N. Y. RC 240
Gentlemen: Enclosed find two remittances of 25c for which send me POSTPAID, one copy of your NEW—1939-40 AMPLIFIER HANDBOOK AND PUBLIC ADDRESS GUIDE.

Send me others, for friends, also POSTPAID @ 25c each.

Name Address

City State

Remit by check or money order; register letter
If you send cash or unused U.S. Postage Stamps.

Please Say That You Saw It in RADIO-CRAFT

A Resume of the Contents of the AMPLIFIER HANDBOOK AND PUBLIC ADDRESS GUIDE

PREFACE

INTRODUCTION

CHAPTER I—FUNDAMENTALS

Vacuum Tube as Amplifier— ratings—Belts and Decibels — Harmonics — Distortion — Attenuation — Gain — Ohm's Law — Bridge Circuits — Rectification — Microphonics — Condensers — Resistors — Impedance — Phase — Resonance — Inductance — Frequency — Magnetism — Shielding

CHAPTER II—VACUUM TUBES

Voltage Amplifiers—Power Amplifiers—Control and Indicator Tubes—Rectifiers—Ballast and Resistor.

CHAPTER III—CIRCUIT ANALYSIS

Input—Coupling—Degeneration (Inverse Feedback) — Frequency Compensation — Outputs—Push-Pull—Phase Inversion—Class A, A-B, B, A1, etc.—Hum-Bucking—Automatic Gain Control—Spectrum Control—Time-Delay—Tone Compensation—Voltage Dividers—Swinging Chokes—Beam Power—Push-Pull.

CHAPTER IV—MICROPHONES

Carbon—Condenser—Electrodynamie—Ribbon (Velocity)—Crystal—Lapel—Uni-directional (cardioid)—Electromagnetic—Transducers.

CHAPTER V—AMPLIFIERS AND PREAMPLIFIERS

A.C.—D.C.—A.C.-D.C. (120 V.)—A.C.-D.C. (6 V. D.C. - 120 V. A.C.)—Mobile—Portable—Multi-Channel—Hi-phonic—Preamplifiers—Monitors.

CHAPTER VI—LOUDSPEAKERS

Magnetic—Dynamic—P.M. Dynamic—Crystal—Horn Units.

CHAPTER VII—HORNS AND BAFFLES

Flat—Infinite—Octave Resonance—Exponential—Flares—Labyrinth—Percydynamic—Hi-phonic.

CHAPTER VIII—AMPLIFIER COMPONENTS

Resistors — Condensers — Transformers — Chokes — Tubes — Sockets — Bezels — Terminals — Jacks and Plugs — Switches — Frequency Filters — Bias Cells — Tone and Volume (Attenuator) Controls—Pads—L, T, H, etc.

CHAPTER IX—POWER SUPPLIES

Power Lines—Batteries—Converters and Generators — Rectifier Tubes — Dry Rectifiers—Vibrators and Inverters—Bias Supplies—Field Exciters—Ballasts and Regulators.

CHAPTER X—ACCESSORIES

Coin Phonographs—P.A. Tuners.

CHAPTER XI—RECORDING AND PLAYBACK

Pickups—33-1/3 and 78 r.p.m. Turntables—Film, Disc and Wire—Recorders—Lateral and Vertical (hill and-dale) Recording—High Fidelity Recording and Playback—Accessories.

CHAPTER XII—MATCHING AND MIXING

Input to Amplifier—Amplifier to Line—Line to Speakers—Pads—Attenuators—Matching Amplifiers —Booster Amplifiers.

CHAPTER XIII—ACOUSTICS

Absorption—Reverberation and Echo—Low Level Distribution—High Level Distribution.

CHAPTER XIV—SELLING SOUND

Etiquette—Who are the prospects?—What are reasonable charges?—Sidelines—Accounting—Advertising and Publicity.

CHAPTER XV—SCHOOL SOUND SYSTEMS

CHAPTER XVI—CALL SYSTEMS

Railroads—Hotels—Restaurants

CHAPTER XVII—INTERCOMMUNICATORS

Wire Type—Wired—Radio Type—Switchless—Multiple Station.

CHAPTER XVIII—TALKIES

Soundheads—Amplifiers—Loudspeakers—Sound-on-Film—Sound-on-Disc—Home-Talkies—Commercial Talkies.

CHAPTER XIX—HEARING AIDS

Tubeless—Tube Type.

CHAPTER XX—MISCELLANEOUS APPLICATIONS

CHAPTER XXI—FORMULAS AND TABLES

CHAPTER XXII—TEST EQUIPMENT

Multi-Meters—C.-R. Oscilloscope—A.F. Oscillators —Output (Level) Indicators—V.T. Voltmeters.

CHAPTER XXIII—INSTALLATION PROCEDURE

Placement of Equipment (Microphones, Amplifiers, Loudspeakers)—Use of Woofers and Tweeters—Wiring Indoors and Outdoors—Portable and Mobile Set-Ups—Permanent Installations.

CHAPTER XXIV—SERVICING

Order Your Copy NOW—

*Clip Coupon and
Mail Today!*

Index to advertisers

A	
Allied Radio Corp.....	492, 499
Amperite Corp.....	491
Amplifier Co. of America.....	507
Arrow Sales Company.....	496
B	
Burstein-Applebee Co.....	491
C	
Capitol Radio Engineering Institute.....	498
Classified Section.....	506
Cornell-Dubilier Elec. Corp.....	507
Coyne Electrical School.....	486
D	
The Data Print Company.....	503
G	
Gold Shield Products.....	498, 502
Goldentone Radio Company.....	493
H	
Hammarlund Mfg. Co.....	512
Hudson Specialties Co.....	508
Hygrade Sylvania Corp.....	488
L	
Lafayette Radio.....	489
Lancaster, Allwine, & Rommel.....	498
Lincoln Engineering School.....	494
M	
Meissner Manufacturing Company.....	487
N	
National Plans Institute.....	502
National Radio Institute.....	449
National Radio Parts Distributors Assn.....	497
National Schools.....	512
National Union Radio Corp.....	495
New York YMCA Schools.....	503
R	
Radio & Tech. Publishing Co.....	496, 497
Radio City Products Co.....	490
RCA Manufacturing Co., Inc.....	489, 512
Radio Servicemen of America.....	500
Radio Training Association.....	502
Radio Wire Television, Inc.....	489
Radolek Company.....	511
RCA Institutes, Inc.....	502
Readrite Meter Works.....	494
Remington Rand, Inc.....	498
S	
E. H. Scott Radio Labs.....	491
Solar Manufacturing Company.....	489
Sprague Products Co.....	Back Cover
Sprayberry Academy of Radio.....	451
Superior Instruments Company	Inside Back Cover, 485
Supreme Instruments Corp.....	493
Supreme Publications.....	501
T	
Technifax.....	507
Triplet Elec. Instrument Co.....	501
Turner Company.....	494
W	
Montgomery Ward & Co.....	495
Earl Webber Company.....	505
Wellworth Trading Co.....	492, 494, 509
Wright, Inc.....	503
Wright-DeCoster, Inc.....	509

(While every precaution is taken to insure accuracy, we cannot guarantee against the possibility of an occasional change or omission in the preparation of this index.)

BOOK REVIEWS

(Continued from page 451)

ence-Building Tools and Their Use, and tends to show that "saturation" in sets-in-use may mean only a "weak solution" as to program effectiveness.

It attempts to bring out the following 3 points: (1) That expert and painstaking audience building can materially increase the success an expertly built program is sure to have; (2) That past experience has already developed a wealth of audience-building opportunities, together with reasonably well-developed techniques for taking advantage of them; (3) That the work of getting the most out of those varied opportunities should be well planned and systematically conducted.

In this book the author offers solutions in connection with the above 3 problems as they concern the American radio listener and as they relate to the field as represented in the figures embraced in the following paragraph: "Of America's 33,000,000 family units, more than 24,500,000 own radios; 4,000,000 homes use 2 or more sets, and 4,500,000 automobiles are radio-equipped, to bring the sets-in-use total to 33,000,000. Those sets are used for 1,000,000,000 person-hours of listening per week, according to one authoritative estimate. Another estimate, admittedly ultraconservative, approximates 700,000,000 hours weekly—still a lot of listening."

THESE AMAZING ELECTRONS, by Raymond F. Yates (1937). Published by The Macmillan Company. Size, 6 x 8 3/4 ins., cloth cover, completely illustrated, 326 pgs. Price \$3.75.

Here is a popular treatise dealing with the applications of the new science of electronics to television, music, medicine, surgery, radio, etc. Worthy of special mention is the excellent selection of illustrations, both as to photographs and drawings.

Avoiding technical language, Mr. Yates, an "old-timer" in the field of radio writers, traces first the development of atomic physics from the discovery of radium and X-rays right up to the present. The author then carries the reader into the everyday world of industry, communication, science and art to show the importance of the electron in these fields.

Chapter headings: World Stuff; The Atom and Its Family Tree; The Waves That Wash Through Matter; More About Light; The Philosopher's Stone and the Quest for Power; Electrons in Wires; Electrons in the Hospital; The New World of Sound; New Horizons in Music; The March of Radio; Television Tomorrow?; The Electric Tube in Overalls; Cosmic Messages; The Electron Lights the World; Electrons Here and There.

16 MM SOUND RECORDING FOR THE AMATEUR, by Carroll A. Nye, Jr., and Samuel T. Golow (1939). Published by Fomo Publishing Company. Size 6 1/2 x 9 1/2 ins., cloth cover, 14 illustrations, 58 pgs. Price, \$1.50.

Mr. A. Shapiro, chief engineer, Ampco Corp., completely outlines in the Foreword the subject of this new book. We quote: "The authors of this valuable treatise have succeeded admirably in clarifying what is generally regarded as an abstruse subject so that the amateur, without professional training, can readily grasp both the principles and operation involved in sound pictures. Through the use of simple language and easily understandable drawings, the theory and practice of sound pictures are set forth so that any amateur can easily understand the ideas and put them into practice. This treatise should do much to popularize active participation in sound recording and reproduction by the amateur."

The half-dozen organizations which are prominent in the field of so-called "home talks" and "industrial movies" have contributed technical material which was used in this book.

Chapters: The Nature of Sound; Sound Recording; Fundamentals of Reproducing Equipment. Only sound-on-film is discussed (sound-on-disc is not).

MOTION PICTURES AND RADIO, by Elizabeth Laine (1938). Published by The McGraw-Hill Book Co., Inc. Size, 6 x 9 ins., cloth cover. 163 pgs. Price, \$1.75.

In "Motion Pictures and Radio—Modern Techniques for Education," Elizabeth Laine combines the publications of The Regents' Inquiry into
(Continued on following page)

Save Money! With the RADOLEK RADIO PROFIT GUIDE!



In the Radolek catalog you will find the MOST for your money! Lowest Prices! Best Quality! Biggest Values! Most Complete Stock! Fastest Service! Send for your FREE copy NOW!

OVER 15,000 REPAIR PARTS

The world's most complete stock of radio repair parts and exact duplicate replacements. All leading brands at lowest prices!



COMPLETE TUBE SELECTION

All types, RCA, Sylvania, Raytheon, Philco, etc. Includes Kellogg, special Majestic and transmitting tubes. Complete selection.



NEWEST TEST INSTRUMENTS

The most complete line ever displayed in any catalog. All leading makes. Includes latest improved 1940 models at lowest prices.



GREATEST RADIO VALUES

A huge selection of money-saving set bargains! New Phono-Radio combinations. Automatic tuning sets. Beautiful cabinets. New "Ham" receivers and equipment.



EVERYTHING FOR AUTO RADIO

Complete new auto radio section. Includes vibrator replacement guide, new auto aerials, custom panel control plates for all autos.



COMPLETE P. A. SELECTION

New 1940 public address amplifiers from 5 to 100 watts. Complete P. A. Systems for permanent, mobile and portable use.



NEW ELECTRICAL APPLIANCES

Extra profits for you! Standard Brand Electric Irons, Stoves, Heaters, Percolators, Waffle Irons, Vacuum Cleaners, Trains, Clocks, Mixers, etc., at lowest prices!



FREE Mail Coupon

The **RADOLEK Co.**

601 W. Randolph, Chicago, Dept. C-38

Send the 1940 Radolek Radio Profit Guide FREE.

Name

Address

Serviceman? Dealer? Experimenter?

Please Say That You Saw It in RADIO-CRAFT

Everybody's giving the New RCA Miniature Tubes a Big Hand!



Introducing a Complete Tom Thumb Tube Complement for Portable Equipment!

THOUGH they are only 2 1/4 inches long, and only 1/4 of an inch in diameter, these new RCA Miniature Tubes are highly efficient in operation with 45-volt B-supply. Their compact size is achieved by a new design which allows a Tom Thumb size without decreasing the size of essential electrode parts. The conventional base has been replaced with a new glass "button 7-pin" base sealed to the glass envelope. Electrodes are mounted directly on

the glass button.

1R5 is an efficient Pentagrid Converter (Filament Voltage—DC 1.4 volts, Filament Current 0.05 ampere) . . . 1S4 is a Power Amplifier Pentode (Filament Voltage—DC 1.4 volts, Current 0.1 ampere) . . . 1S5 is a Diode-Pentode (Filament Voltage—DC 1.4 volts, Current 0.05 ampere) . . . and 1T4, a Super-Control R-F Amplifier Pentode (Filament Voltage—DC 1.4 volts, Current 0.05 ampere). Write for complete information.

Over 335 million RCA Radio Tubes have been purchased by radio users. In tubes, as in radio sets, it pays to go RCA All the Way.



Radio Tubes

RCA Mfg. Co., Inc., Camden, N. J. • A Service of Radio Corp. of America

GET A HANDY ELECTROPLATING KIT ABSOLUTELY FREE!!

Complete details as to how it is possible to get a handy Electroplating Kit absolutely FREE will be found on Page 506 of this issue.

FREE!

HAMMARLUND NEW "40" RADIO CATALOG

The latest Hammarlund catalog with complete data, illustrations, drawings and curves on the entire Hammarlund line. Address Department RC-24 for your free copy.

HAMMARLUND MFG. CO., INC.
424-438 West 33rd Street, New York City

RADIO plus TELEVISION *mastered by pre-tested Training*

No matter where you are or what you do, National has a complete training plan for you—to fit your circumstances. National's Plan is for those seeking immediate shop-training as well as for those who cannot give up present employment and income. Mail coupon for FREE literature.

NATIONAL SCHOOLS

NATIONAL SCHOOLS, Dept. RC-2
4000 So. Figueroa St., Los Angeles, Calif.

Please send free literature and full details

NAME _____ AGE _____

ADDRESS _____

CITY _____ STATE _____

(Continued from preceding page)

the character and cost of public education in the State of New York. The purpose of the inquiry was to plumb the educational systems of the State as to their accomplishments, the fitness of their programs, and cost, and to discuss the pros and cons of projected work and to formulate a subsequent procedure.

The first 4 chapters consider motion pictures; subsequent chapter titles are: Radio as a Medium for Mass Impression; Adaptation of Radio to Education; Educational Projects in Radio Broadcasting; Role of the State in an Educational Radio Program.

WIRELESS WORLD DIARY (1940). Published by Iliffe & Sons, Ltd., Dorset House, London, S.E.1, England. Size, 3 1/2 x 4 1/2 ins., leatherette cover. Price, 50c.

The little diaries which are issued each year by various radio concerns frequently contain very useful information. The new 1940 Diary by the *Wireless World*, Dorset House, Stamford St., London, S.E.1, England, for instance in addition to listing the principal broadcasting stations of Europe contains much information of practical use in the everyday work of the radio man. This includes formulas, abacs and diagrams.

SERVICING "ORPHANS"

Armed with a service diagram, normal operating voltages, plate and cathode currents etc., the average radio technician has little difficulty restoring a standard receiver to its original operating condition. But how about the "orphans" and the "private-brand" receivers which come in for repair? *Radio-Craft* is proud to present in the next (March) issue a highly instructive article covering this question. In tackling this subject the author has made the article so complete that it will be possible to service any receiver where a diagram or service manual may not be available! Don't miss it!

Corrections in Amplifier Articles

In the article, "How to Design a Flexible All-Push-Pull Direct-Coupled 30-W. Amplifier," by A. C. Shaney, in the October, 1939, issue of *Radio-Craft*, an error appeared in the schematic diagram, Fig. 2, pg. 203. Both power supplies should be shown connected in series. That is, the center-tap and associated filter condensers of the high-voltage A.C. winding which supply the plates of the 5V4G should be connected directly to the cathodes of the 6L6G output tubes.

In the article, "A '3-in-2' A.C.-D.C. Midget Amplifier," by H. S. Manney, an error appeared in the schematic diagram on pg. 406. The 3,000-ohm resistor, shown connected between the low-potential end of the output transformer and ground, should not connect to ground, but should be connected between the low-potential end of the output transformer and the screen-grid of the 50L6GT output tube—a very simple change. (January, 1940, issue.)

In the article, "How to Add 1 to 14 Modern Features to the All-Push-Pull Direct-Coupled 30-W. P.A. Amplifier," Part III, by A. C. Shaney, an error appeared in the input-jack circuit of the schematic diagram, Fig. 5, pg. 343. The entire diagram is reprinted below in its corrected form. Terminals X connect to the push-pull output leads. (Dec., 1939, issue.)

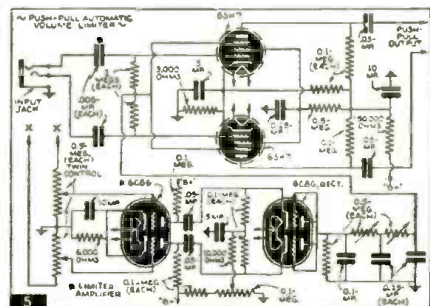

THE NEW 1130-S SIGNAL GENERATOR

WITH AUDIO FREQUENCIES



SPECIFICATIONS

Combination R.F. and Audio Signal Generator, R.F.—100 Kc. to 100 Mc., A.F.—100-7,500 cycles. All direct reading, all by front panel switching. R.F. and A.F. output independently obtainable alone or with A.F. (any frequency) modulating R.F. Accuracy is within 1% on I.P. and Broadcast bands; 2% on higher frequencies. Audio frequencies in 5 bands; 100, 400, 1000, 5000, and 7500 cycles. Giant airplane full vision, direct-reading dial. Condenser and other leakages tested to 100 megohms. All services on 90-130 volts A.C. or D.C. (any frequency). Model 1130-S comes complete with tubes, test leads, carrying handle, instructions. Size 12"x9"x6 1/2". Shipping weight 15 pounds. Our net price **\$11⁸⁵**

THE NEW MODEL 1280

SET-TESTER

Combines
Models 1240
and 1250

A complete testing laboratory in one unit; the Model 1280 combines the Models 1250 Multitester and 1240 Tube Tester. (See specifications of each below.)

- * Instantaneous Snap Switches Reduce Actual Testing Time to Absolute Minimum.
- * Spare Socket and Filament Voltages Up to 120 Volts Make the Model 1280 Obsolescence Proof.
- * Latest Design 4 1/2 D'Arsonval Type Meter.
- * Works on 90 to 125 Volts 60 Cycles A.C.



Even those servicemen who through past purchases know they can always get SUPER-VALUES from Superior, will be amazed and delighted when they read the specifications of this all-purpose instrument and then note the unbelievably low price. The Model 1280 features a 4 1/2" D'Arsonval type meter for easy reading of the various scales, and in line with our new policy of stressing appearance as well as serviceability in our new 1200 line of test equipment, our Model 1280 utilizes an aluminum etched panel, designed for beauty as well as ruggedness. The primary function of an instrument is, of course, to make measurements accurately and when designing test equipment this is our first thought. However, we also appreciate the important part the appearance of an instrument plays in the impression a serviceman makes on his customers, especially on home calls. We have, therefore, paid special attention to the outward design of all of our new instruments. For instance, the panel of this Model 1280 is made of heavy-gauge aluminum and etched by a radically new process which results in a beautiful, confidence inspiring appearance.

Model 1280 comes complete with test leads, tabular data and instructions. Shipping weight 18 pounds. Size 13" x 11" x 6 1/2". Our net price **\$19⁹⁵**

Portable cover \$1.00 additional

THE NEW MODEL 1250 MULTITESTER



SLOPING PANEL
FOR PRECISE
RAPID
SERVICING

Etched
aluminum
panel

Specially designed electronic rectifier enables linear A.C. scale, high stability and little or no temperature drift.

Here is an opportunity to acquire a Multi-Service, Precision Engineered Instrument, for less than you would have to pay for an ordinary Volt-Ohm Milliammeter. Besides making the usual volt, resistance and current measurements (both A.C. and D.C.) this unit accurately measures the CAPACITIES of mica, paper and electrolytic condensers, INDUCTANCE of coils, chokes and transformers, DECIBEL gain or loss, of power amplifiers and public address systems, WATTS output of amplifiers, receivers, etc.

SPECIFICATIONS

Complete A.C. and D.C. Voltage and Current Ranges	High and Low Capacity Scales .0005 to 1 mfd. and .05 to 60 mfd.
D.C. Voltage:—0-15, 0-150, 0-750 volts	3 Decibel Ranges
A.C. Voltage:—0-15, 0-150, 0-750 volts	-10 to +19, -10 to +38, -10 to +53
D.C. Current:—0.1, 0-15, 0-150, 0-750 ma.	
A.C. Current:—0-15, 0-150, 0-750 ma.	Inductance: 1 to 700 Henrys
2 Resistance Ranges 0-500 ohms, 500-5 megohms	Watts: Based on 6 mw. at O.D.B. in 500 ohms .006000 to 600 Watts

Model 1250 works on 90-120 volts 60 cycles A.C. Comes complete with test leads, tabular charts and instructions. Shipping weight 9 lbs. Size 9 1/2" x 11" x 6 1/2". Our net price **\$11⁸⁵**

Portable cover \$1.00 additional

THE NEW MODEL 1240 TUBE TESTER

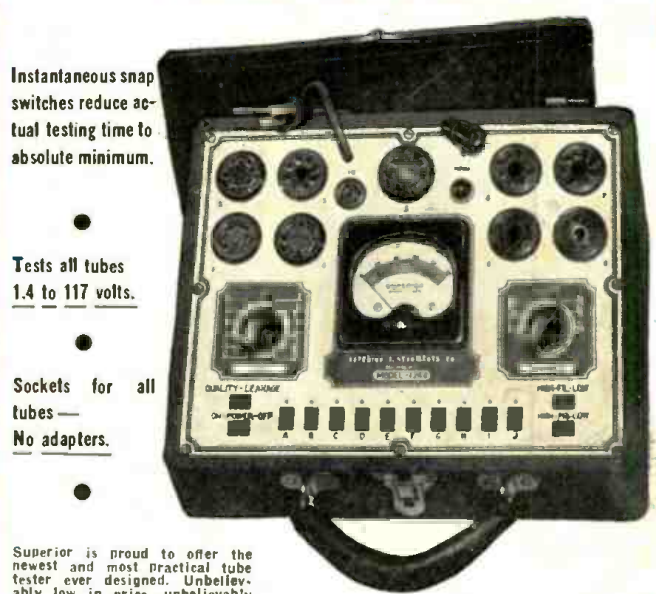

Instantaneous snap switches reduce actual testing time to absolute minimum.

Tests all tubes
1.4 to 117 volts.

Sockets for all
tubes—
No adapters.

Superior is proud to offer the newest and most practical tube tester ever designed. Unbelievably low in price—unbelievably high in performance.

- * Tests all tubes, 1.4 to 117 volts, including 4, 5, 6, 7, 7L, octals, loctals, Bunham Jr., Peanut, single ended, floating filament, Mercury Vapor Rectifiers, the new S series. In fact every tube designed to date.
- * Spare socket included on front panel for any future tubes.
- * Tests by the well-established emission method for tube quality, directly read on the GOOD ? BAD scale of the meter.
- * Jewel protected neon.
- * Tests shorts and leakages up to 2 megohms in all tubes.
- * Tests leakages and shorts in all elements AGAINST all elements in all tubes.
- * Tests BOTH plates in rectifiers.
- * Tests individual sections such as diodes, triodes, pentodes, etc., in multi-purpose tubes.
- * Latest type voltage regulator.
- * Features an attractive etched aluminum panel.
- * Works on 90 to 125 volts 60 cycles A.C.

Model 1240 comes complete with instructions and tabular data for every known type of receiving tube. Shipping weight 12 pounds. Size 6" x 7 1/2" x 10 3/4". Our Net Price **\$11⁸⁵**

Portable cover \$1.00 additional

SUPERIOR INSTRUMENTS CO.

136 LIBERTY ST., DEPT. RC2
NEW YORK, N. Y.

SPRAGUE TEL-OHMIKE

CONDENSER, and RESISTOR ANALYZER



YOU BUY THIS

YOU ALREADY HAVE THESE

By using the milliammeter and voltmeter you already own with Tel-Ohmike, you have a modern, obsolescence-proof instrument worth \$50 for a net price of **\$29.70** only

It Shows Up Intermittent Opens

TEL-OHMIKE saves you money, not only by providing you with a basic instrument which allows you to use the meters you already own, but it saves you valuable working time. It enables you to make more complete and more accurate tests of ALL the characteristics of condensers and resistors in less time than ever before at any price! TEL-OHMIKE measures capacity from .00001 mfd. to 2000 mfd. It measures leakage current and power factor of electrolytic condensers; it measures insulation resistance up to 10,000 megohms. It analyzes air, paper, mica, oil, dry and wet electrolytic condensers under their exact working voltages!

It measures resistance from 0.5 ohms to 5 megohms. All balance indications are given by a "magic eye" tube and all measurements are taken from large, direct reading scales. TEL-OHMIKE indicates open and short circuited condensers, and shows up intermittent open condensers and resistors. TEL-OHMIKE establishes new standards in economy and efficiency in test equipment design. See it at Sprague jobbers, or write directly for a free bulletin.

TWO NEW SPRAGUE LEADERS

KOOLOHM RESISTORS

The biggest improvement in 20 years—with more practical useful features than any other resistor—for no more money

Here are the wire wound resistors you have been waiting for—resistors you can use anywhere at full wattage ratings, even for the highest resistance values—resistors that are completely insulated and operate cooler—resistors that are different in construction and outstandingly superior in performance. All wire in KOOLOHMS is coated before winding with Rubencote, a new heat-proof, moisture-proof insulating material. This permits tightly interleaved windings, larger wire sizes, higher resistance values in less space, and perfect insulation throughout. No fine resistance wires! No cements or enamels! Moisture-proof ceramic jackets provide rugged

mechanical protection and high voltage insulation.

Resistance values guaranteed to plus or minus 5% accuracy. Non-inductive KOOLOHMS with zero inductance even at 50 MC, and distributed capacitance of only 2.5 mmfd., are available at unheard of low prices! All units have Teledot indicators.

Your jobber now has Sprague KOOLOHMS in 5-watt fixed types; 10-watt fixed, 10-watt Non-inductive and 10-watt adjustable.

TELEDOT WATTAGE INDICATOR

Koolohms take overloads better than any other resistors—yet, for double safety, the red dot (Teledot) on the ends of units automatically changes color and warns you when 25% overload occurs. No guesswork. Teledot tells you!

The Dot Changes Color

WIRES TOUCH . . . BUT DON'T SHORT!

Note the interleaved winding pattern of Sprague Koolohms made possible by perfect insulation of the wire itself. Note also (cut-away view) how units are protected mechanically, and insulated electrically, by a hard ceramic outer shell. No danger of chipping or breakage.

BY THE MAKERS OF FAMOUS SPRAGUE CONDENSERS

SPRAGUE PRODUCTS CO. North Adams, Mass.